

## Assembly and Operating Manual

### Air handling unit with heat recovery

**ACCU K 600 F**

**ACCU K 1200 F**

**ACCU K 2400 F**

English

The data specified above only serve to describe the product. No statements concerning a certain condition or suitability for a certain application can be derived from our information. The information given does not release the user from the obligation of own judgment and verification. It must be remembered that our products are subject to a natural process of wear and aging.

This document, as well as the data, specifications and other information set forth in it, are the exclusive property of **ruck Ventilatoren GmbH**. It may not be reproduced or given to third parties without its consent.

The picture on the cover shows an example configuration. The product supplied may therefore differ from the illustration.

The original manual has been produced in the German language.

Information updated: print 16.10.2018  
We reserve the right to make changes

## Assembly and Operating Manual

# Contents

<b>1. Important information</b>	<b>5</b>
1.1. Rules and regulations	5
1.2. Guarantee and liability	5
<b>2. General safety instructions</b>	<b>5</b>
2.1. Intended use	5
2.2. Improper use	6
2.3. Personnel qualifications	6
2.4. Safety instructions in this manual	6
2.5. Adhere to the following instructions	7
2.5.1. General instructions	7
2.5.2. During installation	7
2.5.3. During commissioning	7
2.5.4. During operation	7
2.5.5. During cleaning	7
2.5.6. During maintenance and repair	7
2.5.7. Disposal	7
2.6. Safety labels on the product	8
<b>3. Delivery contents</b>	<b>10</b>
<b>4. Product and Performance description</b>	<b>10</b>
4.1. Device description	11
<b>5. Transport and storage</b>	<b>12</b>
<b>6. Assembly</b>	<b>12</b>
6.1. Permitted installation positions	13
6.2. Duct connections	14
6.3. Application limits	14
<b>7. Electrical connection</b>	<b>14</b>
7.1. Overcurrent protection	15
7.2. Description external inputs and outputs	16
<b>8. Commissioning</b>	<b>17</b>
<b>9. Operation</b>	<b>18</b>
9.1. Control unit	18
9.2. Menu functions	18
9.3. Changing setpoint temperature and fan steps	19
9.4. General value changing	19
9.5. Adjustment of the control unit parameter	20
9.5.1. Language settings	20
9.6. Display user level ACCU K	21
9.7. Menu level Operating parameters (qualified personnel) ACCU K	23
9.7.1. Control type ACCU K-S: Constant volume flow control	23
9.7.2. Control type ACCU K-P: Constant pressure control	29
9.7.3. Control type ACCU K-PV: Constant pressure control with balanced air volume	30

9.8.	Menu level Commissioning .....	33
9.9.	Time / Time switch .....	35
9.9.1.	Setting the current time / day .....	35
9.9.2.	Setting the timer .....	36
9.9.2.1.	Timer on and off switching .....	36
9.9.3.	Setting day - night switch-over .....	37
9.9.4.	System drawings .....	38
9.10.	Functions .....	39
9.10.1.	Fan error message contact .....	39
9.10.2.	Version with electric heating coil .....	39
<b>10.</b>	<b>Maintenance and repair .....</b>	<b>39</b>
10.1.	Important notes .....	39
10.2.	Cleaning and care .....	39
10.3.	Maintenance .....	40
10.3.1.	Thermal mass heat exchanger .....	40
10.3.2.	Air filters .....	41
10.3.3.	Changing the battery .....	42
<b>11.</b>	<b>Modbus communication interface .....</b>	<b>43</b>
11.1.	Wiring diagram .....	43
11.2.	Interface information .....	43
11.3.	Functions implemented .....	43
11.4.	Parameter table .....	44
11.5.	Current value table .....	46
<b>12.</b>	<b>Dismantling and disposal .....</b>	<b>47</b>
12.1.	Disassembling the product .....	48
12.2.	Disposal .....	48
<b>13.</b>	<b>Troubleshooting .....</b>	<b>48</b>
13.1.	Low-current fuses .....	48
13.2.	Fault diagnosis chart .....	49
<b>14.</b>	<b>Technical data .....</b>	<b>51</b>
<b>15.</b>	<b>Appendix .....</b>	<b>52</b>
15.1.	List of parameters .....	52
15.2.	Technical drawings .....	53
15.3.	Wiring diagram .....	55

## 1. Important information

This manual contains important information on the safe and appropriate assembly, transport, commissioning, operation, maintenance, disassembly and simple troubleshooting of the product.

The product has been manufactured according to the accepted rules of current technology.

There is, however, still a danger of personal injury or damage to equipment if the following general safety instructions and the warnings before the steps contained in these instructions are not complied with.

- Read these instructions completely and thoroughly before working with the product.
- Keep these instructions in a location where they are accessible to all users at all times.
- Always include the operating instructions when you pass the product on to third parties.



### 1.1. Rules and regulations

Also observe the generally applicable, legal or otherwise binding regulations of the European or national legislation and the rules for the prevention of accidents and for environmental protection applicable in your country.

### 1.2. Guarantee and liability

**ruck** ventilation devices are produced on the highest technical level according to the generally accepted rules of technology. They are subject to constant quality control and meet the relevant requirements when delivered. Because the products are being constantly developed, we reserve the right to make changes to the products at any time and without prior announcement. We do not accept any liability for the correctness or completeness of this assembly and operating manual.

**The warranty only applies to the delivered configuration. The warranty will not apply if the product is incorrectly assembled or handled or not used as intended.**

## 2. General safety instructions

Planners, plant engineers and operators are responsible for ensuring that the product is installed and operated correctly.

- Use **ruck** ventilation devices only in technically perfect condition.
- Check the product for visible defects, for example cracks in the housing or missing rivets, screws and covers.
- Only use the product within the performance range provided in the technical data.
- Protection against contact and being sucked in and safety distances should be provided in accordance with DIN EN 13857.
- Generally prescribed electrical and mechanical protection devices are to be provided by the client.
- The locking latch can and must only be locked or unlocked with an Allen key SW8.
- Safety components must not be bypassed or put out of operation.
- The product may be operated by personnel with limited physical, sensory or mental capacities only if they are supervised or have been instructed by responsible personnel.
- Children must be kept away from the product.



### 2.1. Intended use

**ruck** ventilation devices are components (partly completed machineries) as defined by the EU Machinery Directive 2006/42/EC. The product is a not ready-for-use machine in terms of the machine directive.

It is intended exclusively for installation in a machine or in ventilation equipment and installations or for combination with other components to form a machinery or installation. The product may be commissioned only if it is integrated in the machinery/system for which it is designed and the machinery/system fully complies with the EC machinery directive.

**Observe the operating conditions and performance limits specified in the technical data.**

**ruck** ventilation products can be used to provide:

- Clean, dry air (no condensation) with a maximum density of 1.2 kg/m<sup>3</sup>. Permitted exhaust air class according to EN 13779 ETA1 / ETA2.
- Fresh air and exhaust air
- The medium and room temperatures and the humidity range given in the technical data and on



the rating plate.

**Intended use includes having read and understood these instructions, especially chapter 2 “General safety instructions”.**

## 2.2. Improper use

Any use of the product other than described in chapter “Intended use” is considered as improper. The following points are improper and dangerous:

- Delivery of explosive and flammable media or operation in potentially explosive atmospheres.
- Delivery of aggressive and abrasive media.
- Delivery of media containing dust or grease.
- Installation outside without any protection against the weather.
- Installation in wet areas.
- Operation without the duct system.
- Operation with closed air connections.
- The operation in the extract air classes ETA 3, 4

## 2.3. Personnel qualifications

Assembly, commissioning, operation, disassembly and service (including maintenance and repair) require basic mechanical and electrical knowledge, as well as knowledge of the appropriate technical terms. In order to ensure operating safety, these activities may therefore only be carried out by qualified technical personnel or a person under the direction and supervision of qualified personnel. Qualified personnel are those who can recognize possible hazards and institute the appropriate safety measures due to their professional training, knowledge, and experience, as well as their understanding of the relevant conditions pertaining to the work to be done. Qualified personnel must observe the rules relevant to the subject area.







## 2.4. Safety instructions in this manual

In this manual, there are safety instructions before the steps whenever there is a danger of personal injury or damage to the equipment. The measures described to avoid these hazards must be observed.

Safety instructions are set out as follows:

**Safety sign (warning triangle)** - Draws attention to the risk.

- **Type of risk!** - Identifies the type or source of the hazard.
- » **Consequences** - Describes what occurs when the safety instructions are not complied with.
- **Precautions** - States how the hazard can be avoided.

Safety sign (warning triangle)	Consequence
	<b>General warning!</b> Indicates possible hazardous situations. Failure to observe the warnings may result in personal injury and / or damage to property.
	<b>Electricity warning (hazardous voltage)!</b> Indicates possible hazards due to electricity. Failure to observe the warnings may result in death, injury and/or damage to property.
	<b>Finger-Crushing Warning!</b> Indicates possible hazards due to moving and rotating parts. Failure to observe the warnings may result in personal injury.
	<b>Overhead load warning!</b> Indicates possible hazards due to overhead loads. Failure to observe the warnings may result in death, injury and/or damage to property.
	<b>Follow important information!</b> <b>Instructions for safe, optimum use of the product.</b>



## 2.5. Adhere to the following instructions

### 2.5.1. General instructions

- Observe the provisions for accident prevention and environmental protection for the country where the product is used and at the workplace.
- Persons who assemble, operate, disassemble or maintain **ruck** products must not consume any alcohol, drugs or pharmaceuticals that may affect their ability to respond.
- Responsibilities for the operation, maintenance and regulation of the product should be clearly determined and observed so that there can be no unclear areas of responsibility with regard to safety.
- Never overload the product. Never use it as a handle or step. Do not place anything on it.
- The warranty only applies to the delivered configuration.
- The warranty will not apply if the product is incorrectly assembled or handled or not used as intended.

### 2.5.2. During installation

- Disconnect all of the product's poles from the mains before installing the product or connecting or removing plugs. Make sure that the product cannot be switched back on again.
- Lay cables and lines so that they cannot be damaged and no one can trip over them.
- Before commissioning, make sure that all gaskets and seals in the plug-in connections are correctly fitted and undamaged in order to prevent fluids and foreign matter getting into the product.
- Information signs must not be changed or removed.

### 2.5.3. During commissioning

- Make sure that all electrical connections are either used or covered. Commission the product only if it is installed completely.
- The power switch must always be fully functional and easy accessible!

### 2.5.4. During operation

- Only authorized personnel is allowed to operate the setting mechanisms of the components or parts, under the provision that the system is used as intended.
- In an emergency, or if there is a fault, or other irregularities, switch the equipment off and make sure it cannot be switched back on again.
- The technical data given on the rating plate must not be exceeded.

### 2.5.5. During cleaning

- Never use solvents or aggressive detergents. Only clean the product using a slightly damp, lint-free cloth. Only use water to do this and, if necessary, a mild detergent.
- Do not use a high-pressure cleaner for cleaning.
- After cleaning, make sure that the product is working correctly again.

### 2.5.6. During maintenance and repair

- If operated correctly, **ruck** products only require a minimum amount of maintenance. Please follow all of the instructions given in section 10 in this respect.
- Make sure that no connections or components are loosened unless the device is disconnected from the mains. Make sure that the equipment cannot be switched back on again.
- Individual components must not be interchanged. For example, the components intended for one product may not be used for other products.

### 2.5.7. Disposal

- Dispose the product in accordance with the currently applicable national regulations in your country.

2.6. Safety labels on the product

ACCU K 600 F Version right

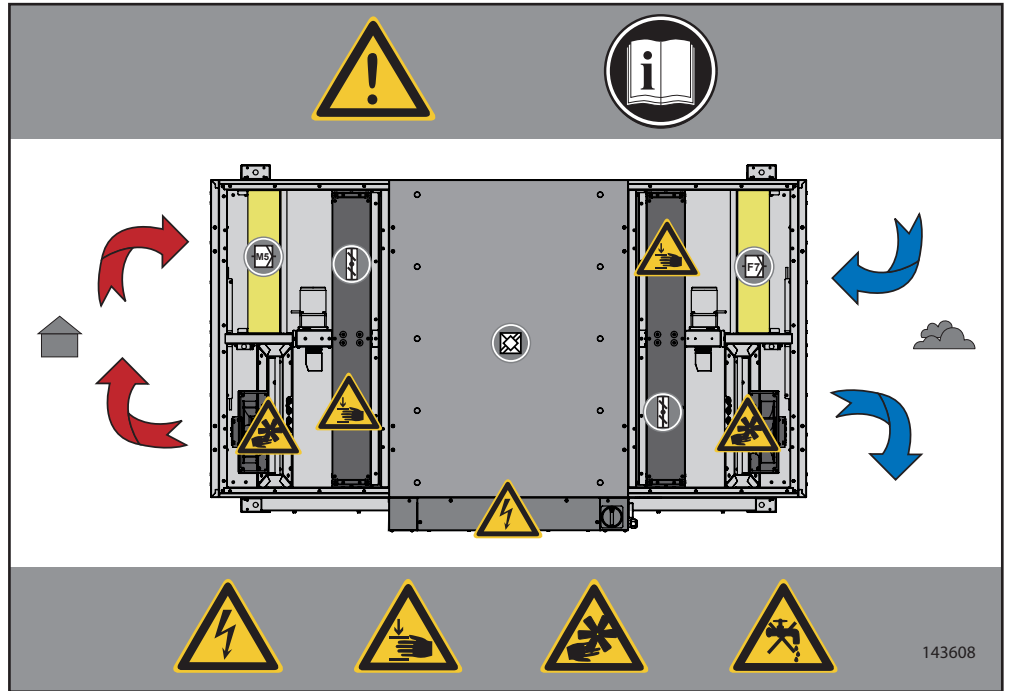
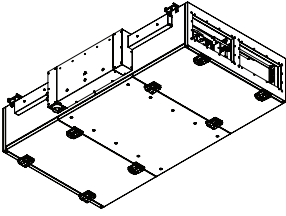

ACCU K 600 F Version left

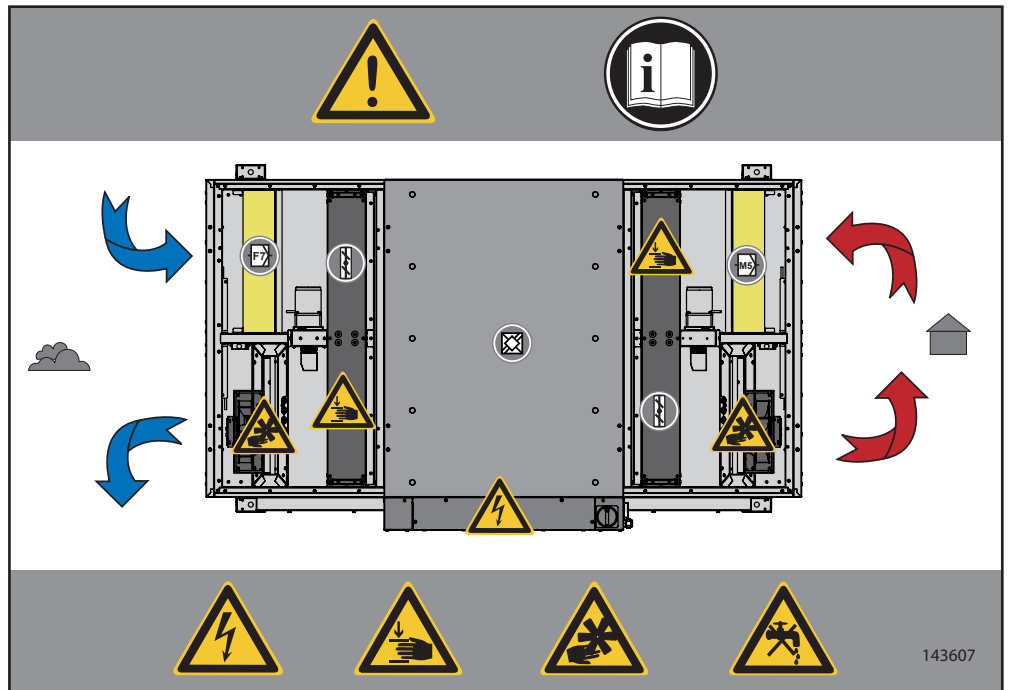
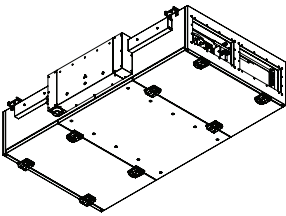



ACCU K1200 F Version right

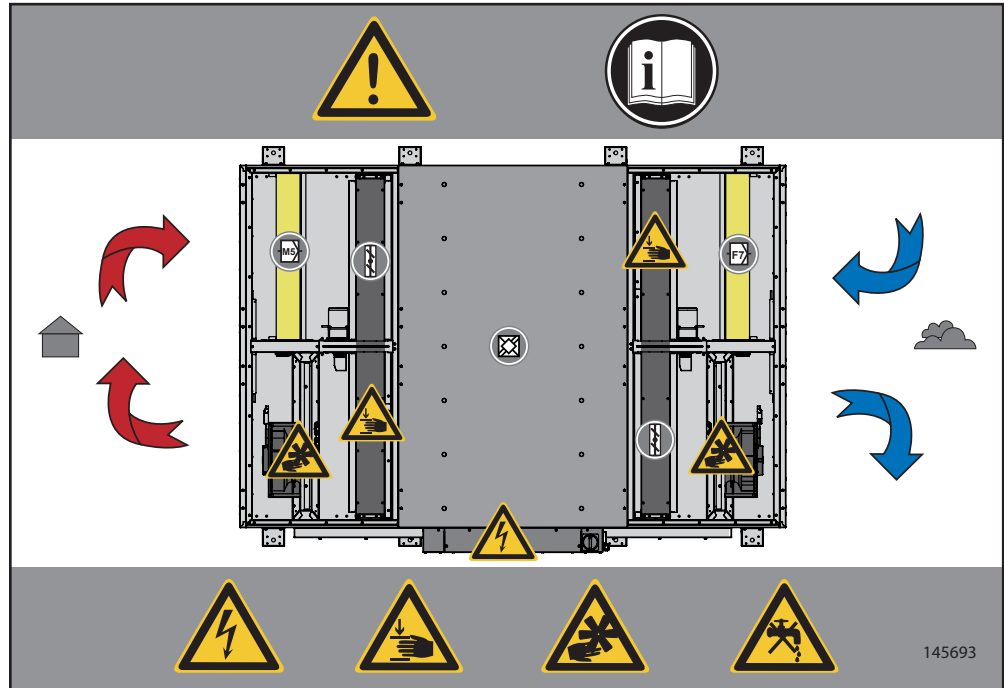
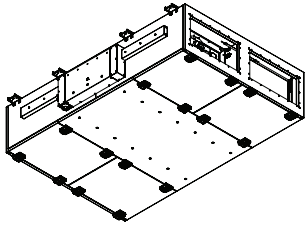

ACCU K1200 F Version left

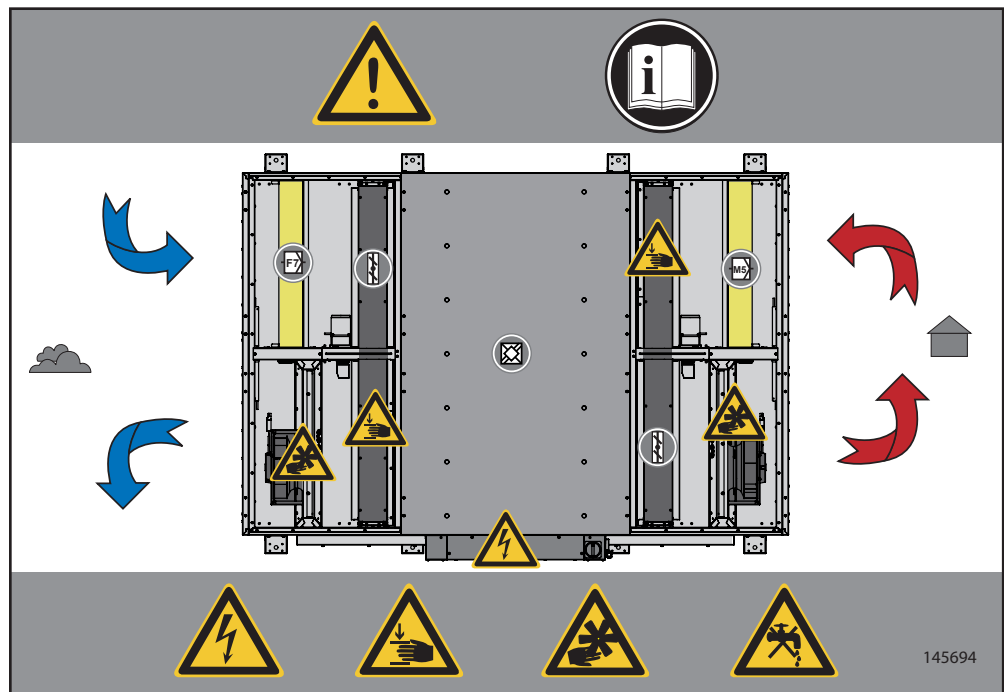
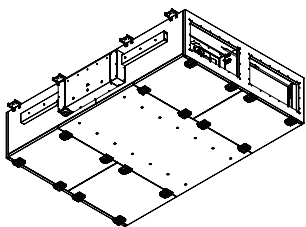

ACCU K 2400 F Version right

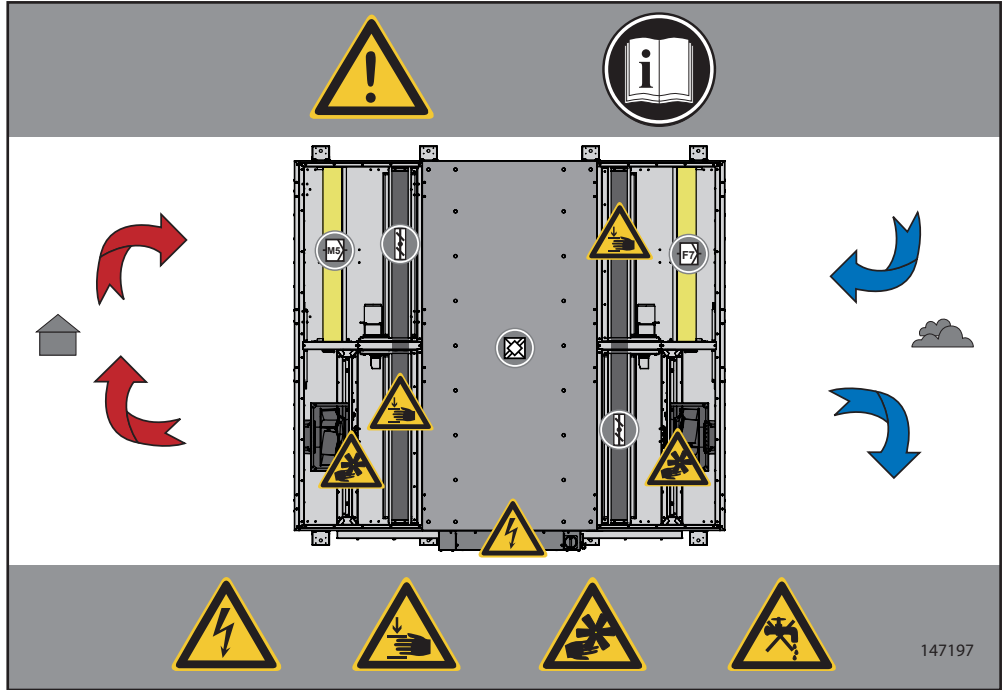
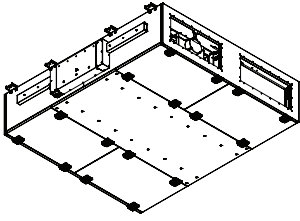

ACCU K 2400 F Version left

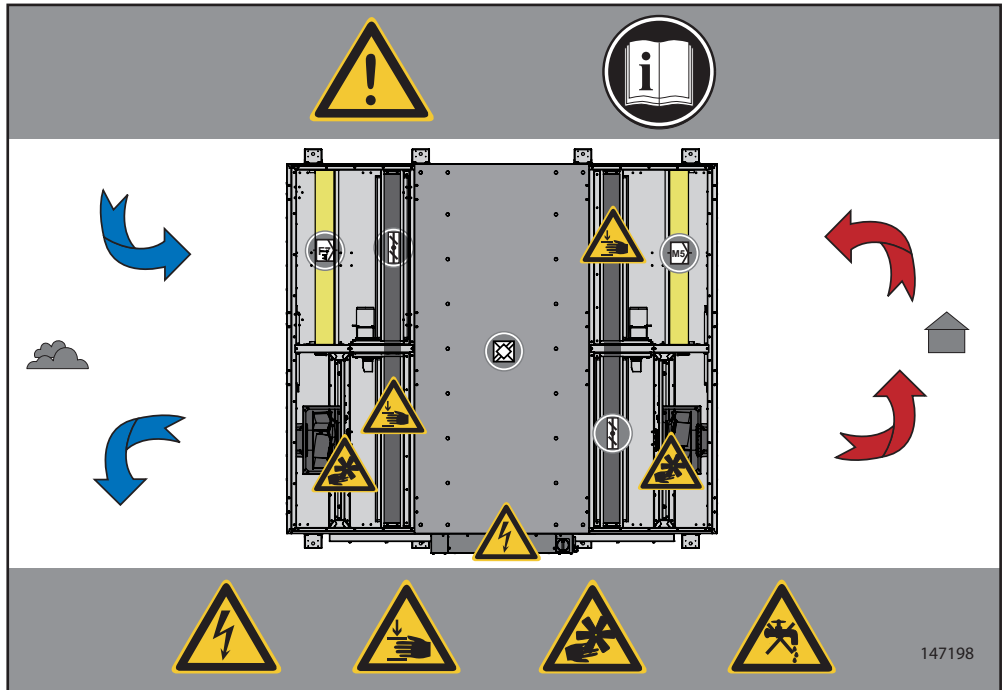
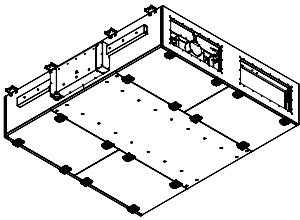



- General warning
- » Failure to observe the warnings may result in personal injury and / or damage to property.
- Unauthorized repairs may cause personal injury and / or damage to property, in which case the manufacturer's guarantee or warranty will not apply.



- Electricity warning (hazardous voltage)!
- » Failure to observe the hazard may result in death, injury or damage to property.
- Before performing any work on conductive parts, always disconnect the unit completely from the electricity supply and make sure that it cannot be switched back on again.



- Never reach into rotating or moving parts.
- » Failure to observe the hazard may lead to serious injury.
- Work may only be performed once the impeller has come to a complete halt.



- Never reach into the impeller or other rotating or moving parts.
- » Failure to observe the hazard may lead to serious injury.
- Work may only be performed once the impeller has come to a complete halt.



Read the operating manual before commissioning the product.



Heat exchanger (thermal mass heat exchanger)



Damper system



- Never clean the internal space with flowing water or a high-pressure cleaner. Do not use aggressive or easily flammable products for cleaning (impellers/housing).
- Only use mild suds. The impeller should be cleaned with a cloth or brush.



Air filter (Panel Filter) Filter class M5



Air filter (Panel Filter) Filter class F7

### 3. Delivery contents

Included in delivery depending on model type:

- ACCU K ... F Ventilation unit with heat wheel exchanger
- 2 x EC fan unit
- 1 x compact filter M5
- 1 x compact filter F7
- 1 x remote control with control cable 10m
- 2 x thermal mass heat exchangers
- 1 x switching flap supply air
- 1 x switching flap extract air
- 1 x assembly and operating manual

### 4. Product and Performance description

ACCU K is a ventilation device with integrated heat exchanger for optimum heat recovery. The device also includes large panel compact filters M5 / F7 and a control unit. The device has a remote control for controlling and setting the operating parameters. The high quality housing consists of a frameless sheet metal structure with smooth internal and external walls. The housing is insulated with 30 mm mineral wool. ACCU K can be operated via Modbus constant air volume or constant pressure as well as via external sensors. The air flow rate can be individually set and ensures demand controlled ventilation. With the integrated timer, the operation times can be individually set for each day of the week.

Data in detail:

- Frameless casing manufactured from galvanized steel sheet.
- Removable heat exchanger.
- Extractable large compact filters M5 / F7.
- Controller installed, wired, ready to plug in.
- Main / Isolator switch
- External control unit with control cable.
- Protection class: in ceiling installation correct duct and cable connection, IPX4 (see 6.1. Permitted installation positions).
- Integrated damper system

### 4.1. Device description

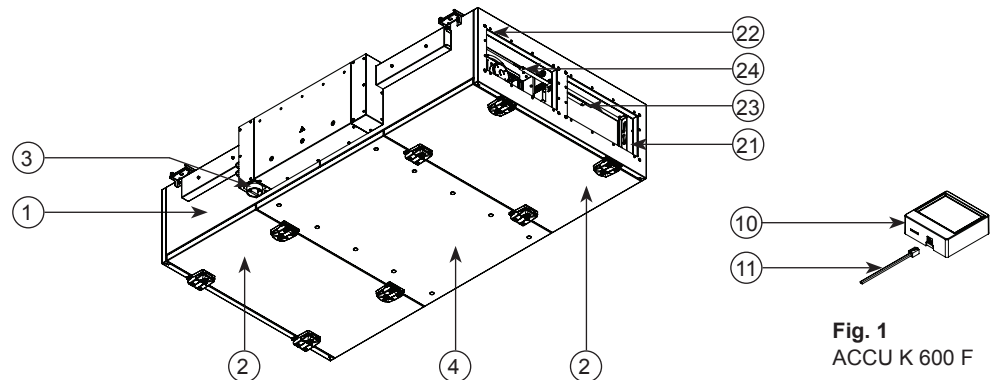

**Fig. 1**  
ACCU K 600 F

**Legend**

- |                                      |  |  |
|--------------------------------------|--|--|
| 1. Housing                           | 10. Remote control                     | 18. Air filter F7 - supply air (0)       |
| 2. Maintenance cover                 | 11. Remote control cable               | 19. Thermal mass heat exchanger          |
| 3. Isolator switch                   | 12. Temperature sensor exhaust air (0) | 20. Air filter M5 - extract air (0)      |
| 4. Cover thermal mass heat exchanger | 13. Controller board                   | 21. Connection extract air (0)           |
| 5. EC-fan                            | 14. Safety labels                      | 22. Connection supply air (0)            |
| 6. Cable glands                      | 15. Switchboard cover                  | 23. Extracted air temperature sensor (0) |
| 7. Rating plate                      | 16. Damper system                      | 24. Supply air temperature sensor (0)    |
| 8. Connection exhaust air (0)        | 17. Temperature sensor fresh air (0)   |  |
| 9. Connection intake air (0)         |  |  |

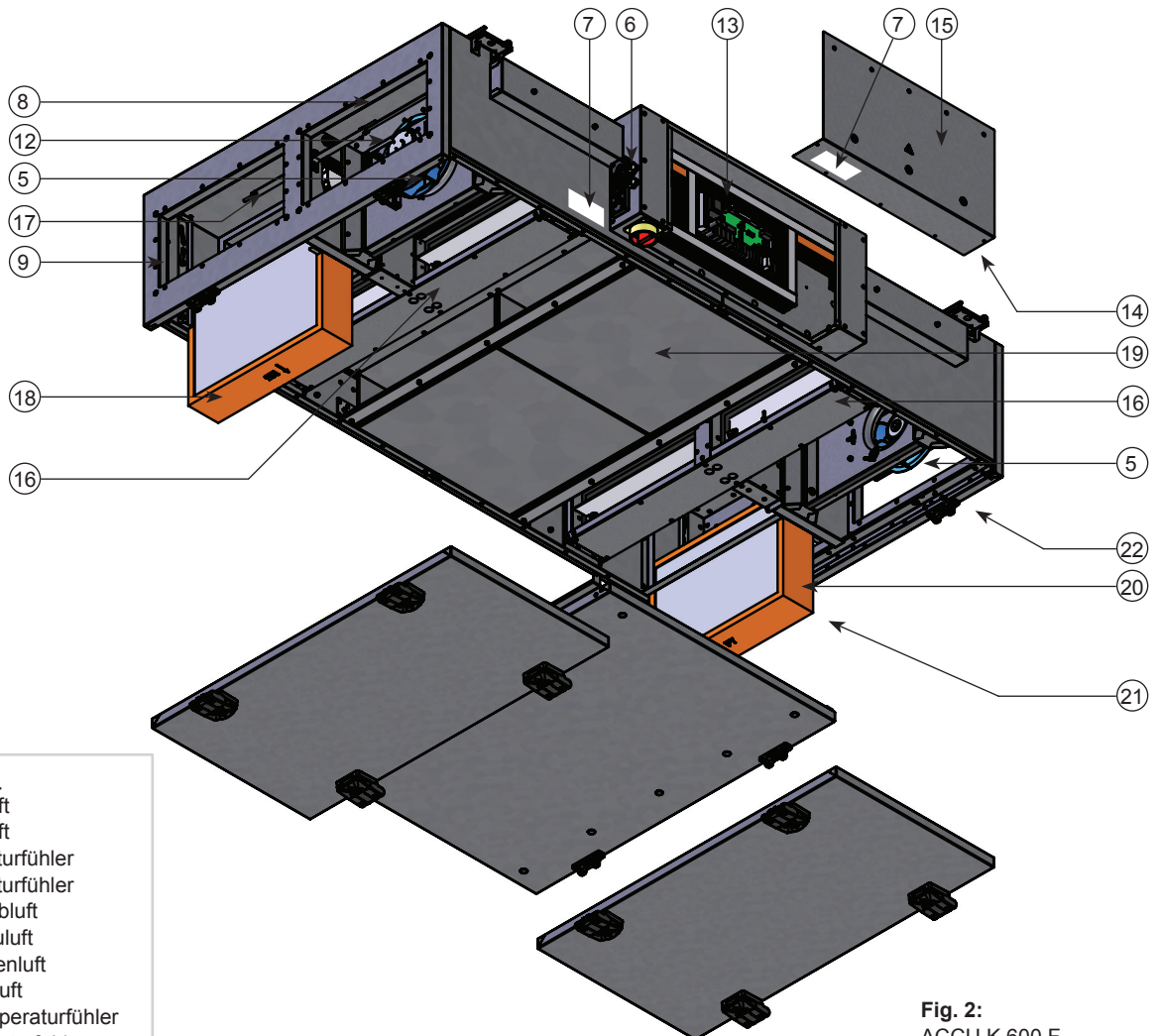

**Ausführung links:**

- 8. Anschluss Zuluft
- 9. Anschluss Abluft
- 12. Zuluft Temperaturfühler
- 17. Abluft Temperaturfühler
- 18. Luftfilter M5 - Abluft
- 20. Luftfilter F7 - Zuluft
- 21. Anschluss Außenluft
- 22. Anschluss Fortluft
- 23. Aussenluft Temperaturfühler
- 24. Fortluft Temperaturfühler

**Fig. 2:**  
ACCU K 600 F

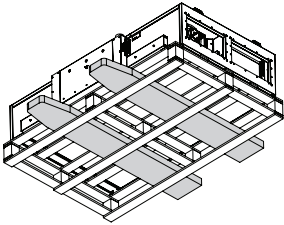

**Fig. 3:**  
Unit transport: lying on a pallet  
with a forklift.

## 5. Transport and storage

Transport and storage should only be performed by specialist personnel in accordance with the assembly and operating manual and regulations in force.

The following points should be noted and followed:

- Check the delivery according to the delivery note to ensure it is complete and correct and check for any damage. Any missing quantities or damage incurred during transport should be confirmed by the carrier. No liability is accepted if this is not observed.
- The weight of the product (see 14. Technical data) depends on the product type in question.
- It should be transported with suitable lifting equipment in the original packaging or on the transport equipment indicated.
- If transported with a forklift, it should be ensured that the product is resting with the basic profile or base frame completely on the forks or on a pallet and the product's centre of gravity is between the forks (see Fig.3).
- The driver must be authorized to drive a forklift.
- Do not go beneath the suspended load.
- Never lift and transport the unit by the door handles, covers or other mounting parts!
- Avoid damage or deformation of the housing.
- The product must be stored in a dry area and protected from the weather in the original packaging. Open pallets should be covered with tarpaulins. Even weatherproof modules should be covered because their weather resistance is only guaranteed after complete installation.
- Storage temperature between +5 °C and +40 °C. Avoid severe temperature fluctuations.
- If the product has been in storage for more than a year, check the smooth running of impellers and valves by hand.



## 6. Assembly

Assembly work may only be performed by specialist personnel in accordance with the installation and operating manual and the regulations and standards in force.

The following points should be noted and followed:

- Mount and align the unit with the aid of a water level. With horizontal air flow, the device can be mounted to the ceiling or on the floor.
- Only suitable installation aids, in accordance with regulations, should be used.
- The installation should be easily accessible for maintenance and cleaning and should be easy to dismantle. For the ACCU K unit, it is necessary to leave a space of at least the height of the unit + 5 cm from other elements to facilitate maintenance work such as changing the filter (see Fig. 5).
- The unit should only be installed with authorized and suitable fastening materials at all fastening points.
- Do not distort the unit when installing.
- The unit should be suitably secured.
- Just use the indicated mounting and fixing places. No holes should be made in the housing or any screws screwed into it.
- The duct system must not be supported on the housing.
- It is recommended that the duct system is attached with flexible connections or connection collars in order to isolate any structure-borne noise. For floor or wall mounting, all units should be mounted to isolate structure-borne noise.
- Make sure that the intake duct has direct access to the intake air.  
**Warning: branches in the intake duct, to other fan units for example, may, if the dimensions are too small, lead to low pressure in the duct and therefore malfunction of the unit.**
- The pressure loss in the duct system must not be more than the capacity of the unit! The pressure loss in the duct should not be more than 2/3 the unit's maximum pressure so that an adequate air output can still be achieved. This will prevent malfunction.
- Pressure losses in the duct system are adversely affected by: the length of the duct system, small duct cross-section, elbows, additional filters, valves, etc.
- According to DIN EN 60204-1:2006 article 5.3.4. Operating handle, the operating means of the supply disconnection shall be easily accessible and located between 0,6 m and 1,9 m above the servicing level. An upper limit of 1,7 m is recommended.
- REMARK: The direction of movement is set forth in IEC 61310-3.
- **Unit suspension must comply with the required minimum load bearing capacity (see Table).**



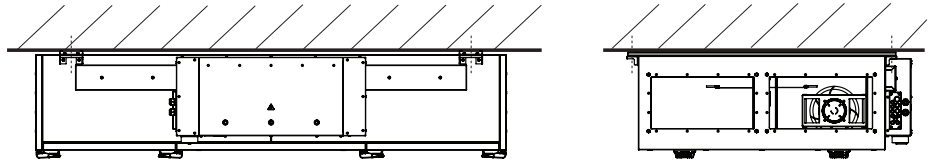

**Fig. 4:**  
Unit suspension  
ACCU K 1200 F

Type	Suspensions	Strength dowel	Weight Devices
ACCU K 600 F	4	1000 N	200 kg
ACCU K 1200 F	8	900 N	363 kg
ACCU K 2400 F	8	1000 N	430 kg

**Table**  
Unit suspension

### 6.1. Permitted installation positions

**Fig. 5:**  
Ceiling installation / Minimum distance for  
maintenance work

Ensure a distance  
of min. 1,5 cm to the  
ceiling.

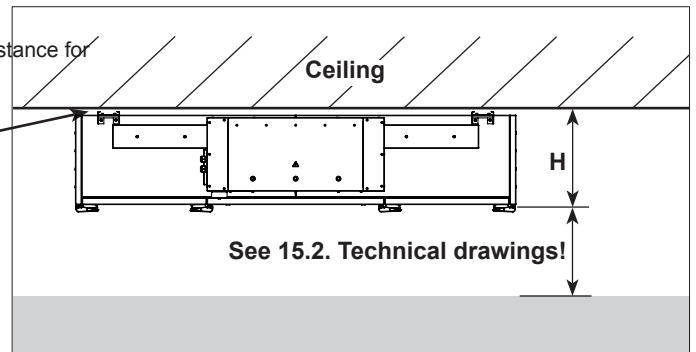

See table on chapter 14. Technical Data for height H.

**Fig. 6:**  
Floor installation

Install insulated against  
structure-borne sound

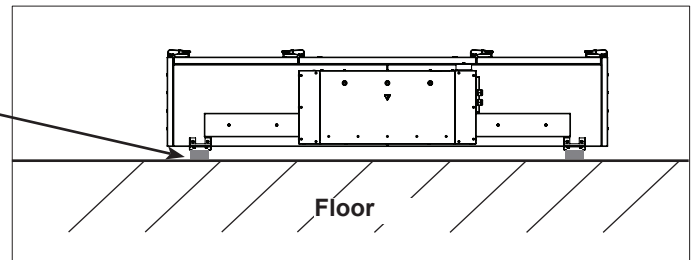

**Fig. 7:**  
Keep the distance to nearby compon-  
ents

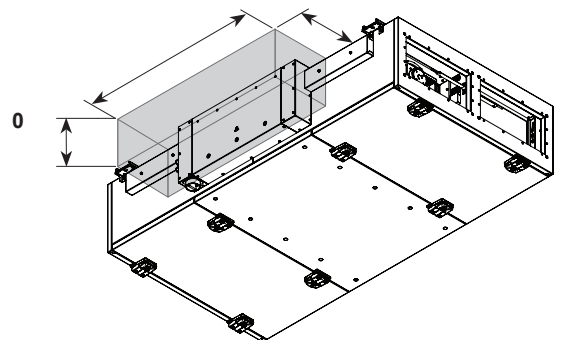

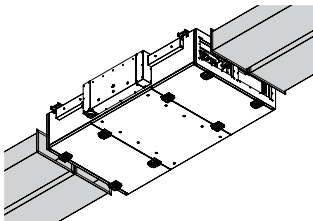

**Fig. 9:**  
Connection air duct

## 6.2. Duct connections

The air tubing has to be executed in such a manner that no condensate/rain or snow from the air duct can enter the unit.

- Insulate cold ducts in warm rooms.
- Insulate warm ducts in cold rooms.

The air connections are to be matched to the connection dimensions. (See under 14. Technical data)

## 6.3. Application limits

### Operation limits of the device

Fresh air temperature	-20 °C to +40 °C
Installation place:	min. +5°C
Extract air class EN 13779	ETA 1 / ETA 2

For the ventilation of rooms whose emission sources are human metabolism or building materials and the buildings are e.g. offices, public areas, meeting rooms.

The suitability for enclosure condensation has to be checked by the customer, it is possible that suitable measures like ventilation of the installation area, or an additional insulation of the outdoor air intake area, are going to be necessary.

Ventilation unit not suitable for outdoor installation.

## 7. Electrical connection



- **Electricity warning (hazardous voltage)!**
- » **Failure to observe the hazard may result in death, injury or damage to property.**
- **Before performing any work on conductive parts, always disconnect the unit completely from the electricity supply and make sure that it cannot be switched back on again.**

Electrical installation may only be performed by qualified electricians in accordance with the installation and operating manual and the national regulations, standards and guidelines in force:

- EN, DIN and VDE specifications, including all safety requirements.
- Technical connection conditions.
- Safety at work and accident prevention requirements.

**This list does not claim to be complete.**

**Requirements should be applied under one's own personal responsibility.**

- The electrical connections must be made as shown in the corresponding wiring diagrams and terminal diagrams.
- The type of cable, size of cable and method of laying should be determined by an authorized electrician.
- Low and extra-low voltage cables should be laid separately.
- An all-pole mains disconnection device with at least 3 mm contact gap must be provided in the supply line.
- Use a separate cable inlet for each cable.
- Any cable inlets that are not used must be sealed so that it is airtight.
- All cable inlets must have strain relief.
- Create equipotential bonding between the unit and the duct system.
- Check all protective measures after the electrical connection work (earthing resistance, etc.)



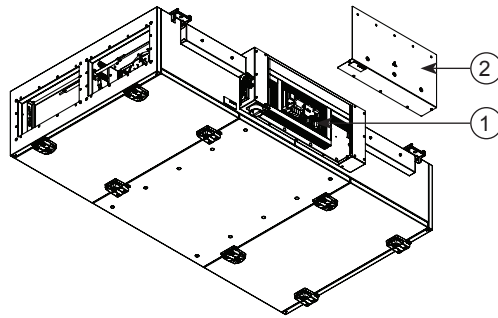

**Fig. 10:**  
Connection compartment  
(1) Controller board  
(2) Switchboard cover

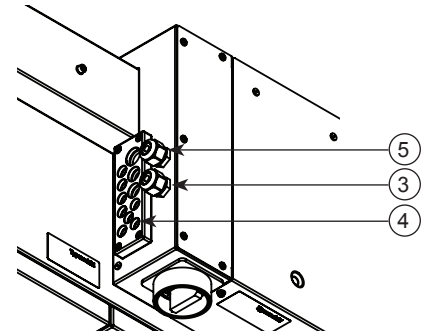

**Fig. 11:**  
Cable glands  
(3) Cable gland power supply  
(4) Cable gland free  
(5) Cable gland control unit

### Connection compartment / Connections on the unit

The connection compartment is inside the unit. At first, remove the terminal box cover (see Fig. 10). Each lead that is connected must pass through a separate cable gland (see Fig. 11). For this, use the supplied cable glands, fittings and cover plate.

Cables that carry mains voltage must be fastened with the tension relief devices available.

### Unit supply cable

Connect the mains supply cable as shown in the wiring diagram. For the dimensioning of the line, observe the unit's rating plate and the relevant guidelines. Suitable fuse protection should be provided.

### Control unit

The control unit is connected to the supply air unit's control system with a control cable.

A connector on the control cable is plugged directly into the socket on the control unit from beneath (see Fig. 12). On the unit, the control cable is first fed through a cable gland (see Fig. 11), placed in the cable duct and then connected to the RJ10 socket provided in the controller board. The control cable must not be shortened. Any excess length must be stowed outside of the housing. If the cable is too short, extensions can be ordered from the manufacturer or supplier. Alternatively, a 4-wire data cable with 120 Ohm resistance can also be connected. This is fed through the back wall of the control unit and connected to the spring-loaded terminals. In the unit, instead of being connected to the controller board in the RJ10 socket, the cable is connected in the spring-loaded terminals next to it (see wiring diagram).

## 7.1. Overcurrent protection



- The unit may only be operated with the correct overcurrent protection.
- This must be established by a qualified electrician.
- The recommended fuse can be found in the technical data. (see under 14. Technical data)



## 7.2. Description external inputs and outputs

### Unit enabling

The unit can be switched on and off with an external potential-free contact (see wiring diagram). An external voltage must never be applied to this connection. The control system would be destroyed. Any devices providing a potential-free contact (e.g. central building control system) can be used to control the unit. This contact must be securely isolated from external voltages because otherwise dangerous conditions might occur in the event of a fault.

The extra-low voltage control cables must be laid separately from the mains cables.

### Motion detector

A motion detector can be connected to the controller. When the contact is closed, the device changes to the operating mode „Intermittent ventilation“ with the preset follow-up time according to parameter 30.

External, potential-free contact.

### Circulation pump enable

A circulation pump can be connected to the controller (see circuit diagram). If heating is required, the heating valve is opened by the controller and the circulation pump output is activated. Any pump connected must be inherently safe and block-proof.

Electrical connection with  $V_{max} = 230 \text{ VAC}$  and  $I_{max} = 2 \text{ A}$ .

### Fire detector

An external, potential-free fire detection contact switches the device off. The display indicates „Error fire protection“. This signals requires a manual reset.

### Modbus RTU

The communication interface with Modbus RTU protocol is already integrated as standard. The central building control system can be connected directly to the integrated interface via Modbus. Multiple devices can be connected to the bus with an adapter board as accessory.

The unit can be visualized using the ruck view software. All parameters, measured and set values can be controlled with ruck view.

### 3-way valve heating

Temperature control for the optional warm water heating coil, e.g. active heating to cover the heating demand by the ventilation system. Control output 3-position. Control output 230V.

### 3-way valve cooling

Temperature control for the optional cold water cooling coil, e.g. active outdoor air cooling by the ventilation system. Control output 3-position. Control output 230V.

### 0-10V heating / 0-10V cooling

Control output for 3-point control or DX-coil.

P 22	0 = Heating (Water)	0-10V (X15: 5,9) Parallel to the 3-point control heating
	1 = Cooling (Water)	0-10V (X15: 5,9) Parallel to the 3-point control cooling
	2 = Heating and cooling (Water)	0-10V (X15: 4,8) Parallel to the 3-point control heating
		0-10V (X15: 5,9) Parallel to the 3-point control cooling
3 = Heating condenser and cooling DX-coil	If contact Enable Cooling opened, 0-10V heating (X15: 5,9) If contact Enable Cooling closed, 0-10V cooling (X15: 5,9)	

### Unit malfunction

If there is a unit malfunction, an error message appears on the display and at the same time switches a relay. A closing and opening signal is available (see wiring diagram). Electrical connection of the changeover contact with  $U = 230 \text{ VAC}$  and  $I_{max} = 2 \text{ A}$ . (There is not any double insulation on the mains cables).

### Frost protection via supply air sensor

If the supply air temperature drops below  $4^{\circ}\text{C}$ , the unit goes into the preheating mode. The dampers are closed, the fans are switched off, the circulation pump is switched on and the heating valve is opened. If the supply air temperature is still below  $4^{\circ}\text{C}$  after 20 minutes, the system switches off completely and the fault message F7 Frost protection appears on the control panel. The circulation pump remains switched on and the heating valve opened. If the supply air temperature rises again within 20 minutes, the device returns to normal operation.

#### Optional frost protection thermostat

An external frost protection thermostat can be connected to the controls. As soon as the temperature drops below the set value, the dampers are closed, the fans are switched off, the circulation pump is switched on and the heating valve is opened. If the set value is not reached after 20 minutes, the system switches off completely and the fault message F7 Frost protection appears on the control panel. The circulation pump remains switched on and the heating valve opened. If the supply air temperature rises again within 20 minutes, the device returns to normal operation.

#### Release cooling machine

On cooling demand the potential-free contact will be closed.

If the set value is reached, if the supply air temperature sinks below 16°C, the contact will be opened.

#### External 0 - 10V input

An external measuring transducer can be connected to the 0 - 10V input for demand controlled ventilation. Fan control according parameters in chapter 9.2. Commissioning level.

#### External pressure sensor

Two pressure sensors can be connected to the control unit for the operation with constant pressure control. One sensor for extract air pressure, one sensor for supply air pressure.

## 8. Commissioning



- **Electricity warning (hazardous voltage)!**
- » Failure to observe the hazard may result in death, injury or damage to property.
- Before performing any work on conductive parts, always disconnect the unit completely from the electricity supply and make sure that it cannot be switched back on again.



- **CAUTION! Crushing hazard! Interval switching of the dampers!**
- » Failure to observe the hazard may lead to serious injury.
- Switch off the device by the isolator switch before opening the device.



- **Never reach into the impeller or other rotating or moving parts.**
- » Failure to observe the hazard may lead to serious injury.
- Work may only be performed once the impeller has come to a complete halt.



Commissioning by trained technical personnel may only be performed when any risk has been ruled out. The following checks should be performed in accordance with the installation and operating manual and the regulations in force:

- Correctly sealed installation of the unit and duct system.
- Check the duct system, unit and medium lines, if present, remove any foreign bodies if necessary.
- The intake opening and inflow into the unit must be clear.
- Check all mechanical and electrical protection measures (e.g. earthing).
- Voltage, frequency and type of current must correspond with the rating plate.
- Check all electrical connections and wiring.
- Check any electrical, switching, safety and control devices connected.
- The unit may not be switched on when the housing is open.
- Check the fan for excessive vibrations and noise generation.

**During commissioning also calibrate the filters! See under 9.6. Menu level Operating parameters - parameter P27.**

## 9. Operation

### 9.1. Control unit

The control unit allows the selection and the command of various unit functions. The control unit has an integrated temperature sensor (set-point sensor) for measuring the room temperature. The display shows the various operating parameters and error messages. You can switch between displaying different menu points and make changes to your unit settings and values.

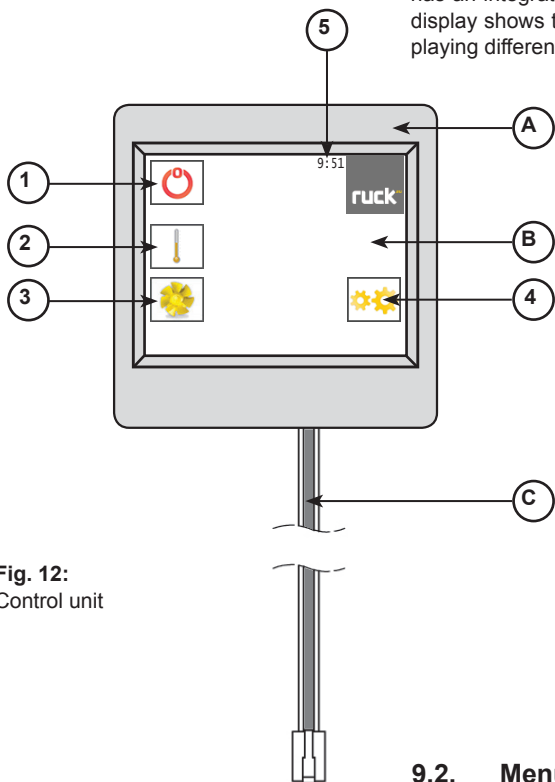

- A) Control unit
- B) Display: Operating display
- 1) ON/OFF selection:
- 2) Setpoint temperature:
- 3) Fan steps:
- 4) Settings:
- 5) Display: current time
- C) Control cable

Fig. 12:  
Control unit

### 9.2. Menu functions

#### OPERATING DISPLAY

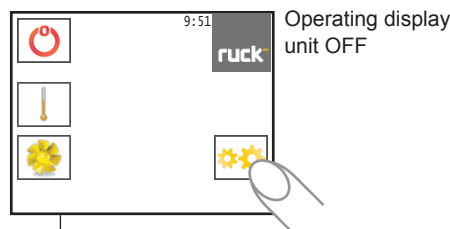

Operating display  
unit OFF

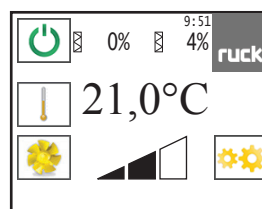

Operating display  
unit ON

#### SELECTION MENU

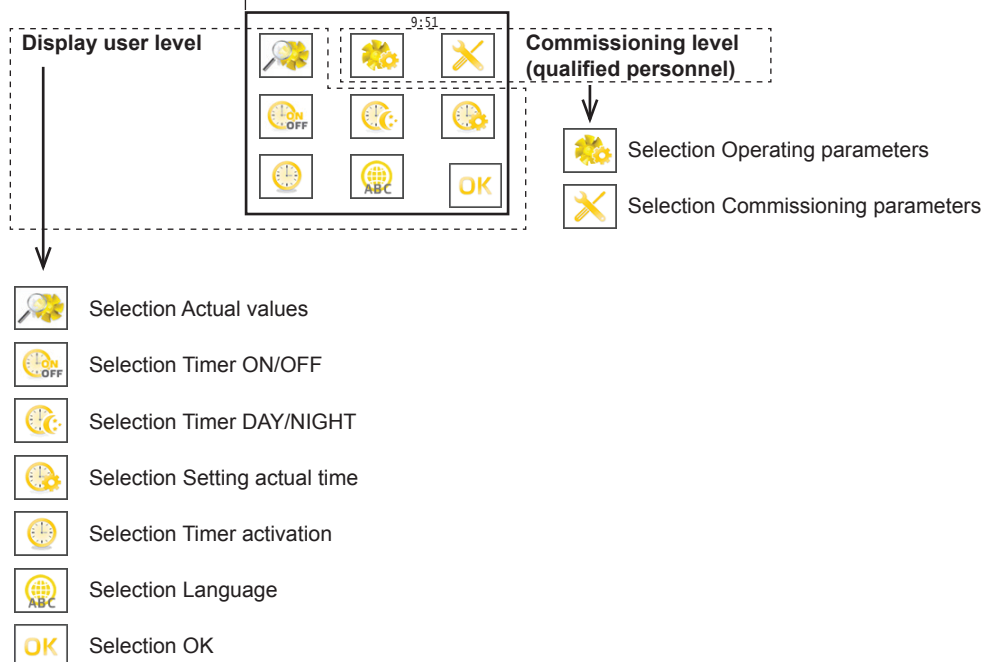

### 9.3. Changing setpoint temperature and fan steps

#### Switching the unit on/off on the control unit.

By selecting „ON/OFF“, the unit is switched on or off  
The unit's status now appears on the display with the current values.

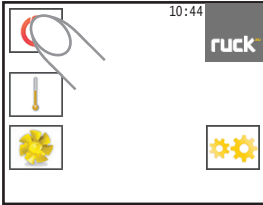

- ⏻ » Set-point temperature display
- ⌚ » Time switch
- 🧻 » Contamination degree of the filters
- 😊 » CO2 / VOC control

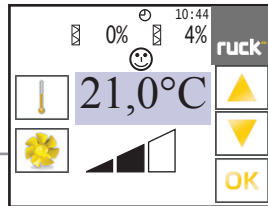
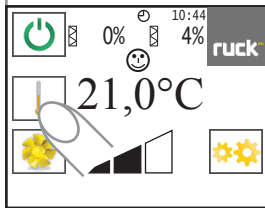

#### Changing the set-point temperature

When commissioning for the first time, a set-point value of 21 °C is given. This value is shown on the display. The selection buttons „▲“ and „▼“ can increase or reduce the setpoint value at the control unit. *(The setting range is limited by parameters P 1 and P 2.)*

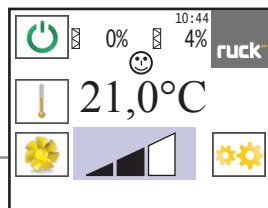
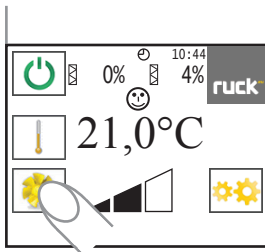

#### Change fan step

Fan step 2 is preset at first commissioning. This value is shown on the display. The selection buttons „▲“ and „▼“ can increase or reduce the fan step at the control unit.

### 9.4. General value changing

Hachured fields in the Instructions Manual indicate values that may be changed. To change them, you have to select the value which then turns grey.

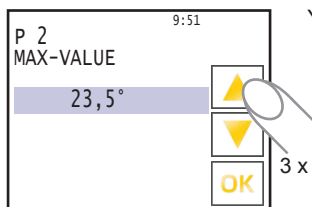
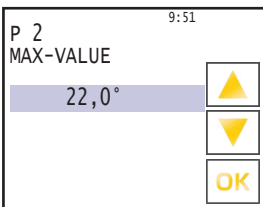
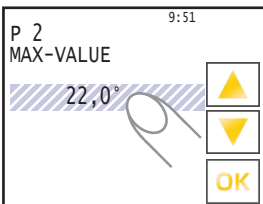

You can now change the values with the buttons „▲“ and „▼“.

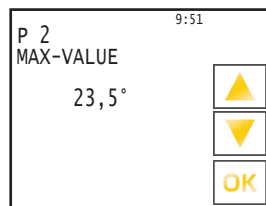
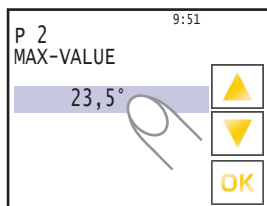

If the desired value is set, you can confirm it with a simple touch. You can further go through the menu with the buttons „▲“ and „▼“ or return to the Operating display with „OK“.

## 9.5. Adjustment of the control unit parameter

To access the menu for setting the control unit parameters, you have to touch the „Settings“ icon.

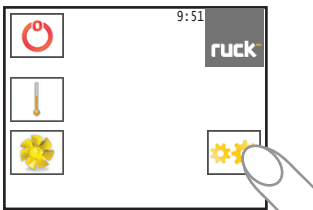

The display shows the selection menu. By touching the desired icon, you can change between the parameters you need.

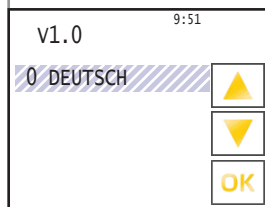
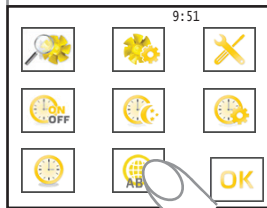

### 9.5.1. Language settings

Choose the parameter language settings with the selection field „Language“. You can now choose the desired language with the buttons „▲“ and „▼“.

You may choose between the following languages:

0 DEUTSCH	German	10 РУССКИЙ	Russian
1 ENGLISH	English	11 TURKISH	Turkish
2 FRANCAIS	French	12 SLOVENCINA	Slovenian
3 DANSK	Danish	13 HRVATSKI	Croatian
4 ESPANOL	Spanish	14 MAGYAR	Hungarian
5 NEDERLANDES	Dutch	15 MONGOLOOR	Mongolian
6 PORTUGUES	Portuguese	16 SUOMI	Finnish
7 POLSKI	Polish	17 ČESKÝ	Czech
8 SLOVENCINA	Slovakian	18 SVENSKA	Swedish
9 ROMANA	Romanian		

By selecting „OK“, you confirm the chosen language.  
The display switches into operating display.

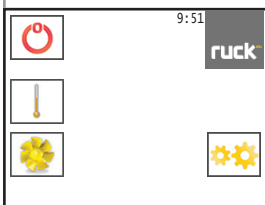

## 9.6. Display user level ACCU K

You access the menu of the user level by touching the „Settings“ icon. The selection menu will then appear on the display.

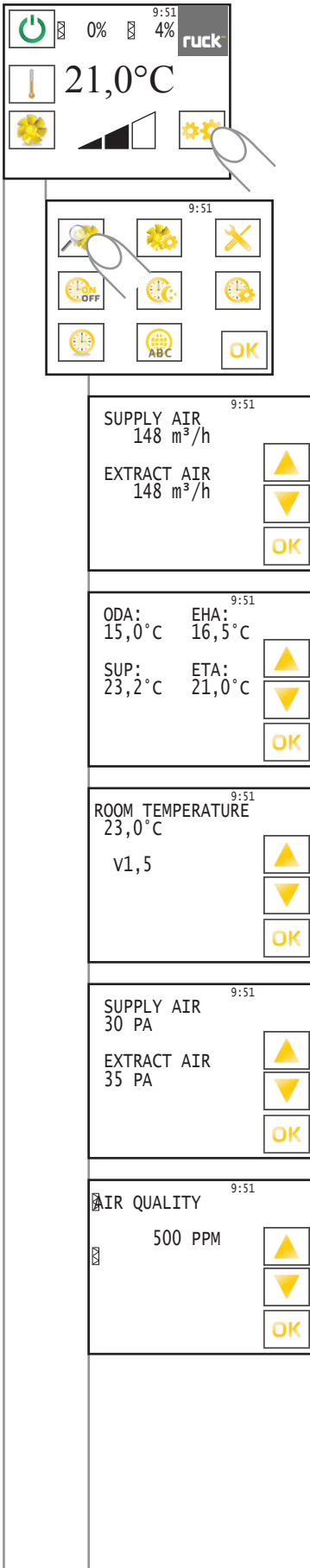

### Selection menu

You can see the actual values by touching the „Actual values“ icon.

### Actual values

Display only, no changes are possible.

You can display the individual menu points with the selection tools „▲“ and „▼“. You can go back to the Operating display at any time by touching „OK“.

### Actual value volumetric flow

Display of the actual running volumetric flow.

### Temperatures

Display of the currently prevailing air temperatures in the device.

ODA » Outside air - temperature

SUP » Supply air - temperature

ETA » Extract air - temperature

EHA » Exhaust air - temperature

### Room temperature

Shows the actual room temperature value, measured by a temperature sensor in the room.

The value after V shows the software version of your unit.

### Pressure loss at the filter

Display for the current pressure loss at the filters.

### Air quality

Displays the current air quality

Displayed only when CO<sub>2</sub> or VOC sensor is active.

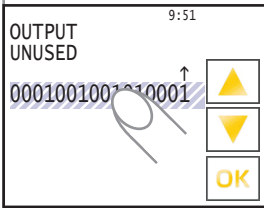

**Control unit outputs**

Display of the assigned outputs on the control unit.

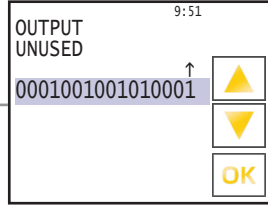

The individual outputs can be queried with the selection tools „▲“ and „▼“  
The selection is made from right to left.

Description:  
0 = no relay connected  
1 = relay connected

Position:	Consequence:	Description:
1	unimplemented	UNUSED
2	unimplemented	UNUSED
3	1 = on	ENABLE COLDNESS
4	unimplemented	UNUSED
5	unimplemented	UNUSED
6	1 = opening	HEAT. VALVE OPEN
7	1 = closing	HEAT. VALVE CLOSE
8	1 = on	CIRCULATOR PUMP
9	1 = error	FAULT RELAIS
10	unimplemented	UNUSED
11		ANTIFREEZ. HEATER
12	1 = opening	COOL. VALVE OPEN
13	1 = closing	COOL. VALVE CLOSE
14		FLAP M2
15		FLAP M1
16	unimplemented	UNUSED

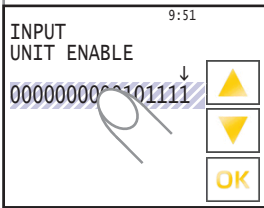

**Control unit inputs**

Display of the assigned inputs on the control unit.

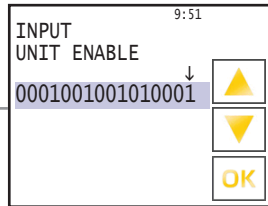

The individual inputs can be queried with the selection tools „▲“ and „▼“  
The selection is made from right to left.

Description:  
1 = true  
0 = false

Position:	Consequence:	Description:
1		UNIT ENABLE
2	1 = OK	FRQ. CONVER. FAULT
3	1 = OK	MOTOR PROTECTION
4	1 = OK	FROST PROTECTION
5		MOTION DETECTOR
6	1 = OK	FIRE PROTECTION
7		SWITCH FOR M2
8		SWITCH FOR M1
9	unimplemented	UNUSED
10	unimplemented	UNUSED
11	unimplemented	UNUSED
12	unimplemented	UNUSED
13	unimplemented	UNUSED
14	unimplemented	UNUSED
15	unimplemented	UNUSED
16	unimplemented	UNUSED

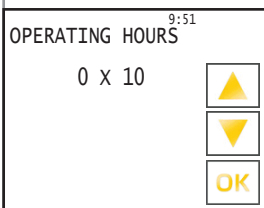

**Hours of operation**

The current number of hours for which the unit has been in constant operation.

- Value x 10 in hours.

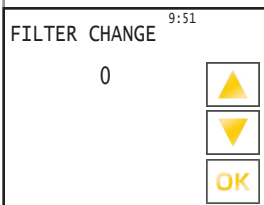

**Filter change counter**

Number of filter changes made. The value rises automatically whenever a filter has been correctly changed.

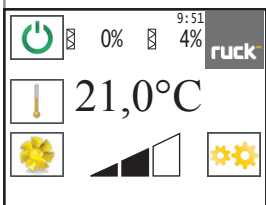

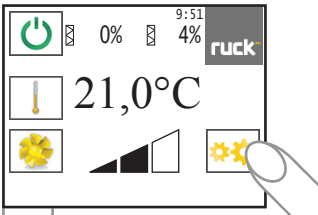

### 9.7. Menu level Operating parameters (qualified personnel) ACCU K

You can access the Commissioning level by selecting the „Settings“ icon. The display then shows the selection menu.

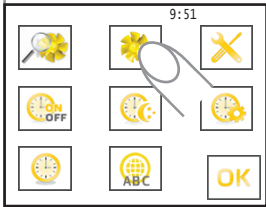

#### Selection menu

Now you can access the Operating parameters by touching the „Operating parameters“ icon.

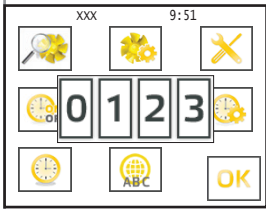

It is necessary to provide a password. This will remain valid for 30 min. After 30 minutes it is necessary to retype the password in order to continue making changes.

Password: 0213 (is shown as XXX near the time)

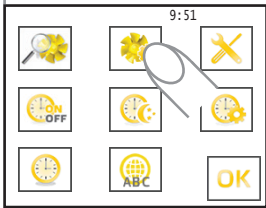

Now you have to select „Operating parameters“ again.

#### 9.7.1. Control type ACCU K-S: Constant volume flow control

When confirming constant air volume control, the following parameters have to be adjusted/checked.

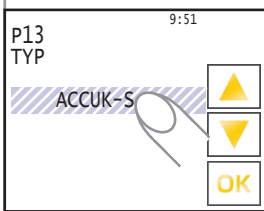

#### P 13 ACCU K-S

Variable control with constant volume operation

Factory setting

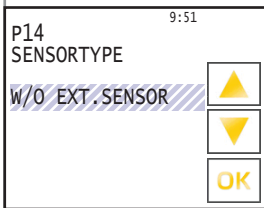

#### Sensor type -W/O EXT.SENSOR-

##### P 14 without external sensor

Constant air volume control active

Factory setting

also available for selection

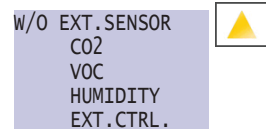



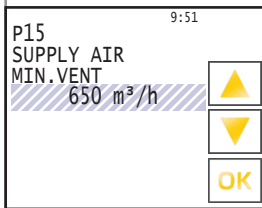

#### P 15 Minimum ventilation supply air / P 16 Minimum ventilation extract air

The volumetric flow can also be adjusted to „MINIMUM VENTILATION“ (night setback). This parameter is controlled using the timer switch or Level 1 and can be set across the entire air volume range.

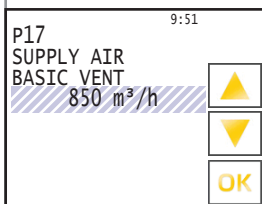
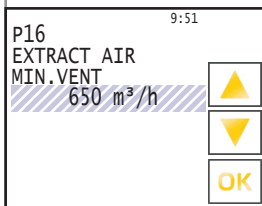

#### P 17 Basic ventilation supply air / P 18 Basic ventilation extract air

The designed volume flow for the „BASIC VENTILATION“ is set in m³/h on the control unit and regulated via the parameters P17 and P18 at Level 2. The required duct pressure for „BASIC VENTILATION“ can be set in Pa with the control unit. The duct pressure can be individually set for supply and extract air. P 14 External control

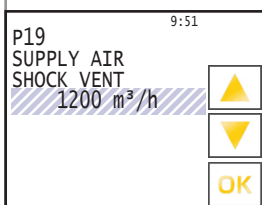
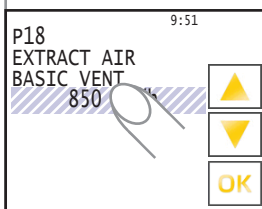

#### P 19 Intermittent ventilation supply air / P 28 Intermittent ventilation extract air

The air handling unit runs on closing the external contact to the motion sensor and in Level 3 at the volume flows set in P19 and P28.

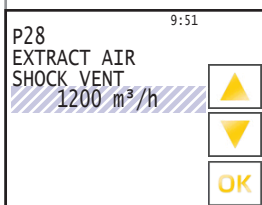

Continued on page 30!

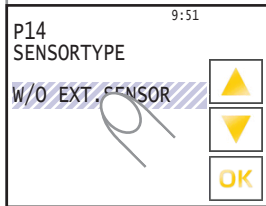

Factory setting

### Sensor type -CO2-

#### P 14 Sensor type CO2

Volumetric flow, demand controlled by CO2 of the extract air

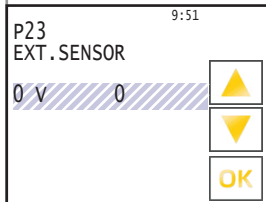
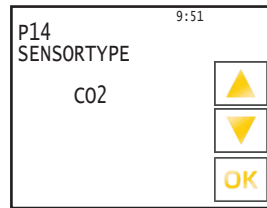
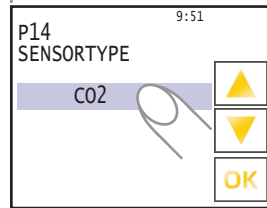
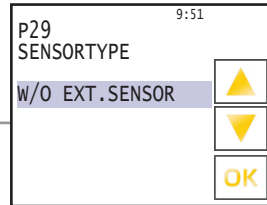

#### P 23 and P 24

These settings can be found in the measuring range of the used measuring transducer. The measuring range is already preset for devices with integrated CO2 sensor.

Example: Measuring area sensor 0 - 5000 ppm

P 23 = 0  
P 24 = 5000

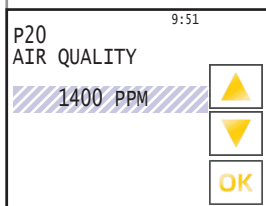
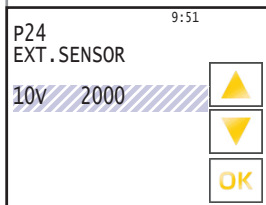

#### P 20 Air quality

When using external measuring transducers, the maximum air flow rate can be adjusted by parameter P 20.

Example:

Class room      CO<sub>2</sub>:      Measuring area sensor 0 - 5000 ppm  
                          VOC:      Measuring area sensor 0 - 5000 ppm

Continued on page 30!

### Sensor type -VOC-

#### P 14 Sensor type VOC

Volumetric flow, demand controlled by external measuring transducer (VOC)

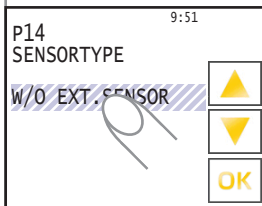

Factory setting

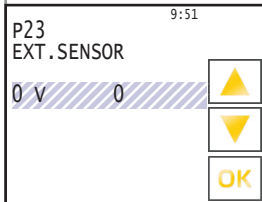
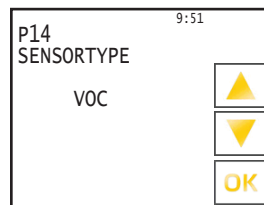
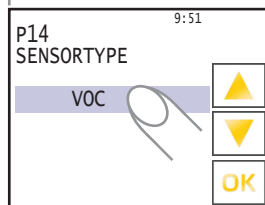
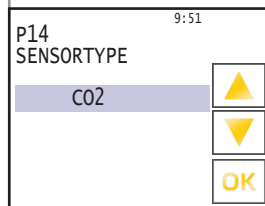
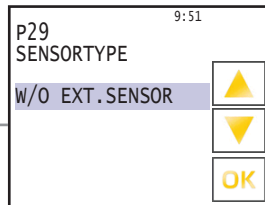

#### P 23 and P 24

These settings can be found in the measuring range of the used measuring transducer. The measuring range is already preset for devices with integrated CO2 sensor.

Example: Measuring area sensor 0 - 5000 ppm

P 23 = 0

P 24 = 5000

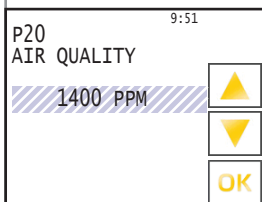
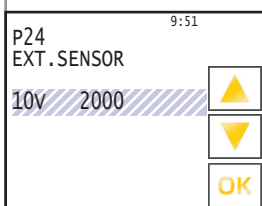

#### P 20 Air quality

When using external measuring transducers, the maximum air flow rate can be adjusted by parameter P 20.

Example:

Class room	CO <sub>2</sub> :	Measuring area sensor 0 - 5000 ppm
	VOC:	Measuring area sensor 0 - 5000 ppm

Continued on page 30!

**Sensor type -HUMIDITY-**

**P 14 Sensor type humidity**

Volumetric flow, demand controlled by external measuring transducer (humidity)

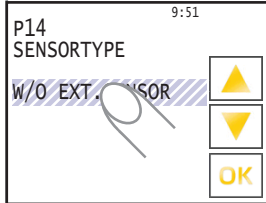

Factory setting

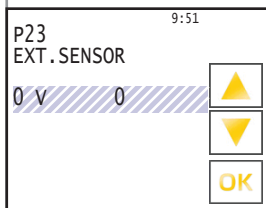
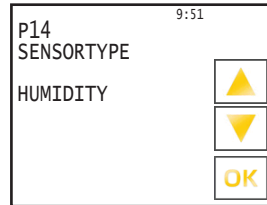
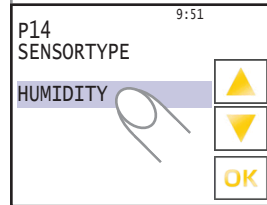
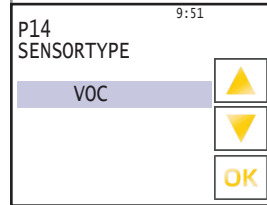
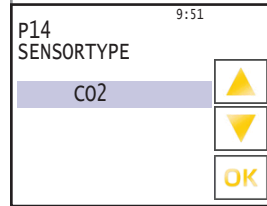
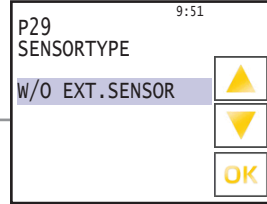

**P 23 and P 24**

These settings can be found in the measuring range of the used measuring transducer. The measuring range is already preset for devices with integrated CO2 sensor.

Example: Measuring area sensor 0 - 100 %

P 23 = 0

P 24 = 100

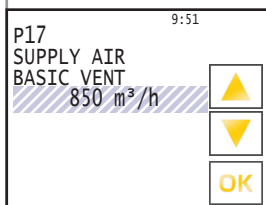
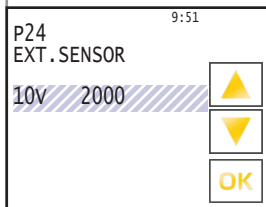

**P 17 Basic ventilation supply air**

0

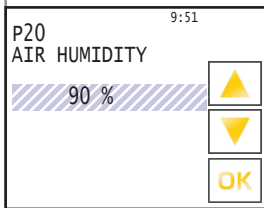

**P 20 Air humidity**

When using an external humidity sensor you can set the desired air humidity under parameter P 20. If the measured air humidity lies below the set value, the unit will provide the air volume set under P 17 basic ventilation.

Continued on page 30!

**Sensor type -EXT.CTRL.-**

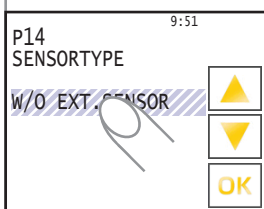

Factory setting

**P 14 External control**

External volume flow control via 0 - 10 V input (see wiring diagram).

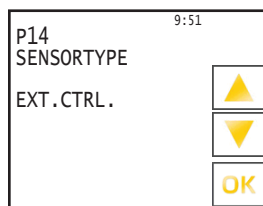
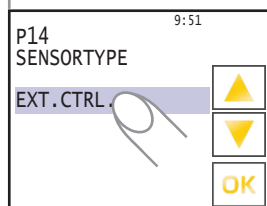
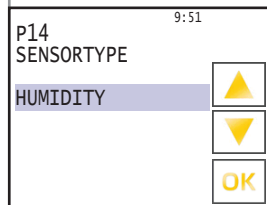
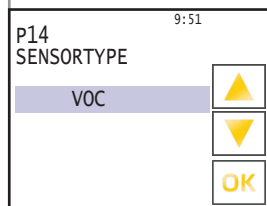
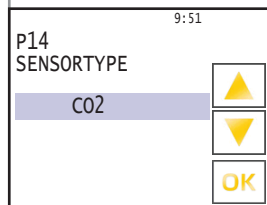
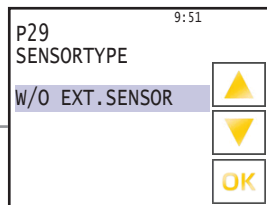

Continued on page 30!

### 9.7.2. Control type ACCU K-P: Constant pressure control

#### P 13 ACCU K-P Constant pressure control

Operating mode P is the common control mode for the operation with variable air volumes by variable air volume controllers. The desired supply and extract air pressure can be set with the control unit. Two pressure sensors SEN P are necessary for this operating mode. The device does not balance the air volume. We recommend a reheater for this operating mode to control the air volume balance.

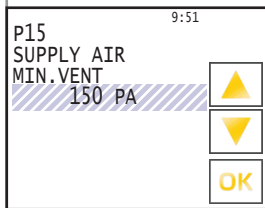
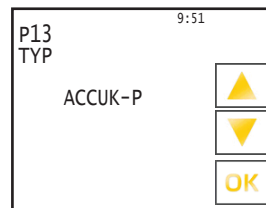
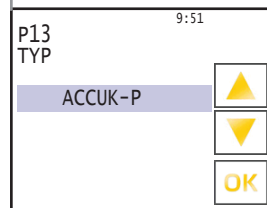
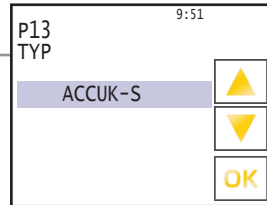
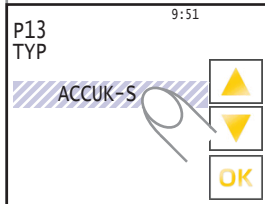

#### P 15 Minimum ventilation supply air / P 16 Minimum ventilation extract air

The volumetric flow can also be adjusted to „MINIMUM VENTILATION“ (night setback). This parameter is controlled using the timer switch and can be set across the entire allowed pressure range.

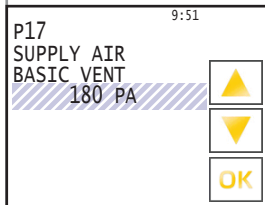
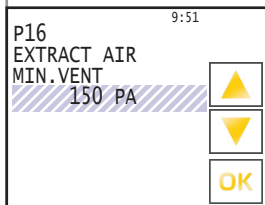

#### P 17 Basic ventilation supply air / P 18 Basic ventilation extract air

The required duct pressure for „BASIC VENTILATION“ can be set in Pa with the control unit. The duct pressure can be individually set for supply and extract air.

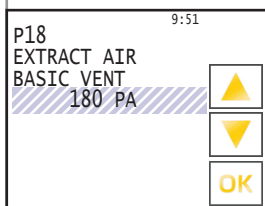

Continued on page 30!

### 9.7.3. Control type ACCU K-PV: Constant pressure control with balanced air volume

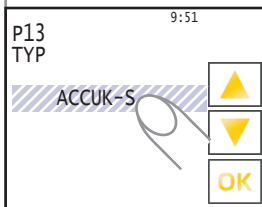

#### P 13 ACCU K-PV Constant pressure control with balanced air volume

The operating mode PV is set for air-tight low-energy houses with variable air volumes by variable air volume controllers. The device automatically balances the air volume when sections will be added on or switched off. The desired supply pressure must only be set on the control unit. A response of the air volume controller is not necessary.

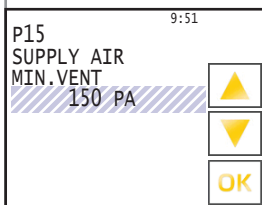
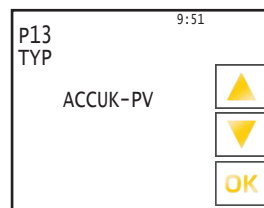
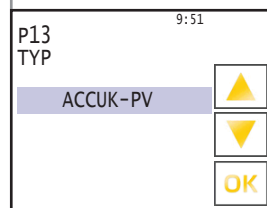
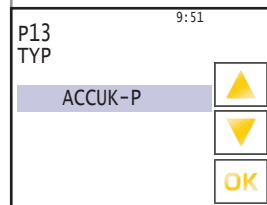
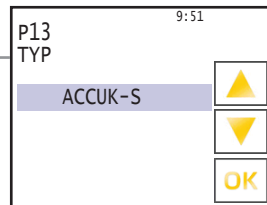

#### P 15 Minimum ventilation supply air

The duct pressure can also be adjusted to „MINIMUM VENTILATION“ (night setback). This parameter is controlled using the timer switch and can be set across the entire allowed pressure range.

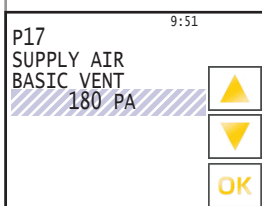

#### P 17 Basic ventilation supply air

The duct pressure required for „BASIC VENTILATION“ can be set on the control unit in Pa. The extract air volume automatically follows up the supply air volume. Expensive control methods can thus be omitted and the air volume balance for the building ventilation can be automatically implemented.

Continued on page 30!

The following parameters are for all types of control:

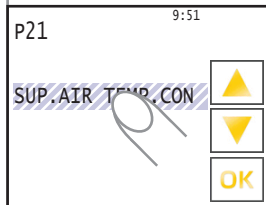

Factory setting

**P 21 Room, supply or extract air temperature regulation**

The room, supply air or extract air temperature regulator compares the air temperature measured at the temperature sensors with the reference temperature set on the control unit. In the case of heating, a difference between the set-point and actual temperature causes the controller to increase or reduce the heat output.

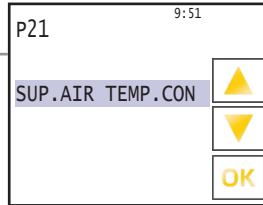

**P 21 Supply air temperature control**

With supply air temperature control, the external heat source is not taken into account. Fixed supply air temperature. No other adjustability.

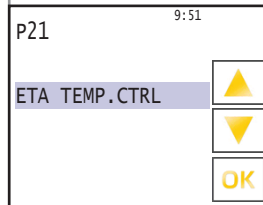

**P 21 Extract air temperature control**

With extract air regulation, any external heat source in the room will be taken into account and compensated for by a correction to the supply air. Fixed extract air temperature. No other adjustability.

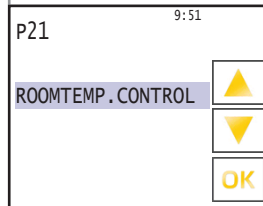

**P 21 Room temperature control**

With room temperature control, any external heat source in the room will be taken into account and compensated for by a correction to the supply air temperature. The room temperature sensor is in the control unit.

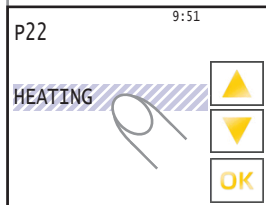

Factory setting

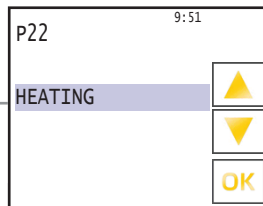

**P 22 Heating**

The air handling unit is operated in WRG mode and with a warm water heat register or external electric heat register\*. 3-point control or 0-10V

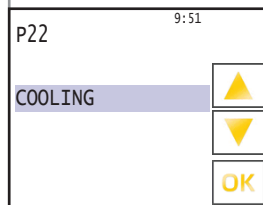

**P 22 Cooling**

The air handling unit operates in heat recovery mode. 3-point control or 0-10V

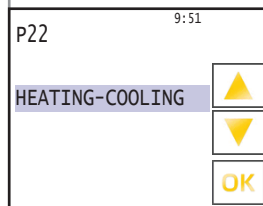

**P 22 Heating and cooling**

Only with option Warm water heating coil or Electric heater\* and option cooling coil.  
Heating: 3-point control or 0-10V  
Cooling: potential-free contact ON / OFF, 3-point control or 0-10V



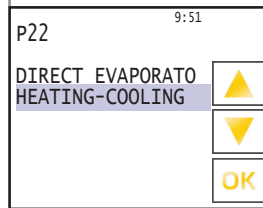

**P 22 Heating and cooling (direct expansion)**

Only with option Warm water heating coil or Electric heater\* and option cooling coil.

Heating: 3-point control or 0-10V

Cooling: potential-free contact ON / OFF, 3-point control or 0-10V

\* The electric heaters are controlled by the internal bus.

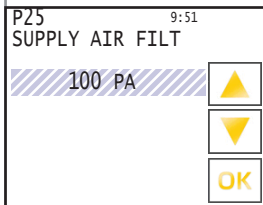

**P 25 Supply air filter pressure loss**

Setting for pressure loss at the supply air filter before the filter is clogged or 100% clogging is reached. The current level of clogging can be seen on the status display. The factory setting is 100 Pa.

You might have to optimize the settings if a different type of filter is used.

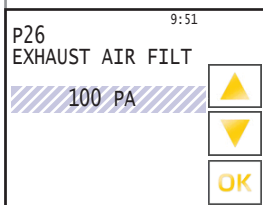

**P 26 Extract air filter pressure loss**

Setting for pressure loss at the supply air filter before the filter is clogged or 100% clogging is reached. The current level of clogging can be seen on the status display. The factory setting is 100 Pa.

You might have to optimize the settings if a different type of filter is used.

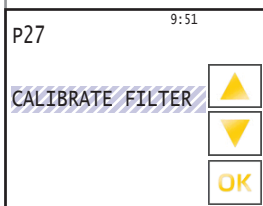

**P 27 Calibrate filter**

Calibrating the pressure loss at the unclogged filter.

The calibrated value corresponds to 0% clogging.

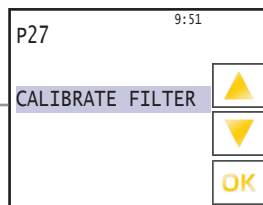

The entire ventilation system has to be complete in order to execute the filter calibration.

By touching the icon „▲“, the unit switches to the calibration mode. Display flashes „CALIBRATE FILTER“.

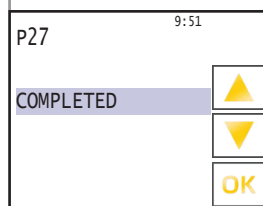

After calibration, the display shows „COMPLETED“.

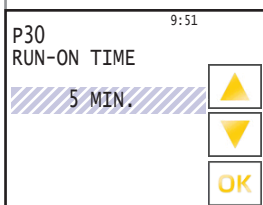

**P 30 Follow-up time**

This parameter sets the stop delay of the motion detector input. The device runs for intermittent ventilation with the adjusted time according to parameter 19 and 28.

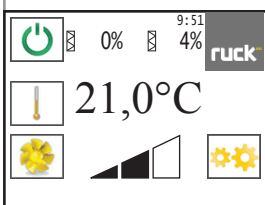

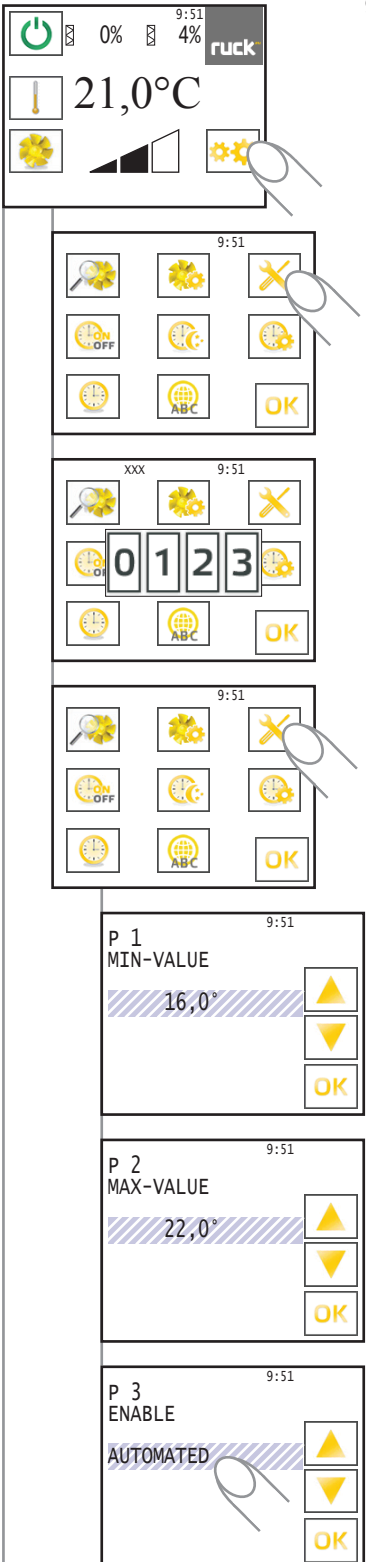

## 9.8. Menu level Commissioning

You can access the parameter settings by selecting the „Settings“ icon. The selection menu will then appear on the display.

### Selection menu

Next you enter the Commissioning level by selecting the icon „Commissioning parameters“.

It is necessary to provide a password. This will remain valid for 30 min. After 30 minutes it is necessary to retype the password in order to continue making changes.

Password: 0213 (is shown as XXX near the time)

You must now select again „Commissioning parameters“.

The display then changes to „P 1 MIN-VALUE“.

The individual menu points may be queried with the icons „▲“ and „▼“. By selecting the values (shown hachured here) you may activate them (shown in grey) and afterwards you can change the values with „▲“ and „▼“. You can go back to the Operating display by touching „OK“.

### P 1 Minimum set-point value

The parameter P1 shows the lowest setpoint temperature which you may set with the control unit. Values between 16 °C and 20 °C can be selected. The default setting is 16 °C.

### P 2 Maximum set-point value

The parameter P2 shows the highest setpoint temperature which you may set with the control unit. Values between 20 °C and 30 °C can be selected. The default setting is 22 °C.

### P 3 Enable

Switching the unit on and off with an external contact  
The unit must be switched on at the control unit.

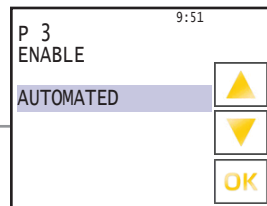

Contact open. The unit is switched off.  
Contact closed. The unit is switched on / ready for operation.

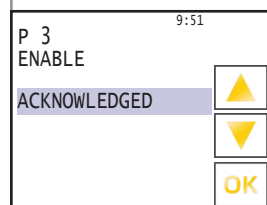

The unit can only be switched on if the contact is closed. If the contact is open, the display will show „NOT ENABLE“. The contact has to be closed and at the end confirmed by selecting „OK“. The default mode is AUTOMATIC.

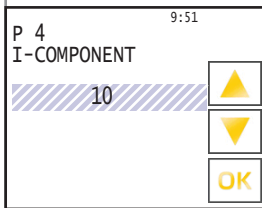
**P 4 I - component**

A value between 5-20 can be set for the I – component.

The factory setting is at 10.

If the value decreases, the control becomes more sensitive.

CAUTION! Due to highly sensitive settings, the control tends to pulsate.

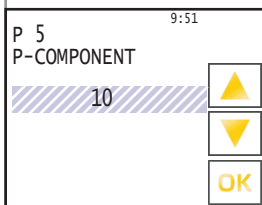
**P 5 P - component**

A value between 5-20 can be set for the P – component.

The factory setting is at 10.

If the value increases, the control becomes more sensitive.

CAUTION! Due to highly sensitive settings, the control tends to pulsate.

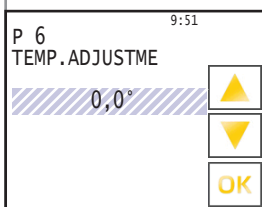
**P 6 Temperature correction**

The room temperature sensor within the control unit may show some deviation from the actual room temperature. In this case, the control sensor can be corrected in the range from -5 °C to 5 °C.

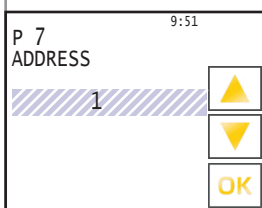
**P 7 Address**

The bus address can be set between 1 and 247 with parameter P27 on the control unit.

Every unit with a Bus connection has to have an individual address.

Make sure that an address is not used for two devices. This can lead to malfunctions of the complete bus system.

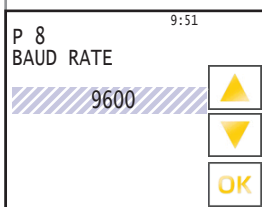
**P 8 Baud rate**

The baud rate defines the data speed.

2400, 4800, 9600, 14400 and 19200 baud rates can be set.

1 stop bit (fixed), no parity

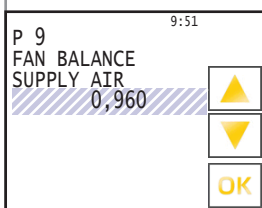
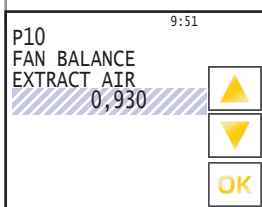
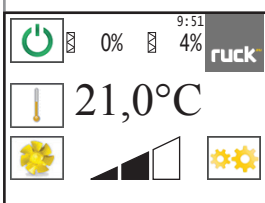
**P 9 Fan calibration supply air****P 10 Fan calibration extract air**

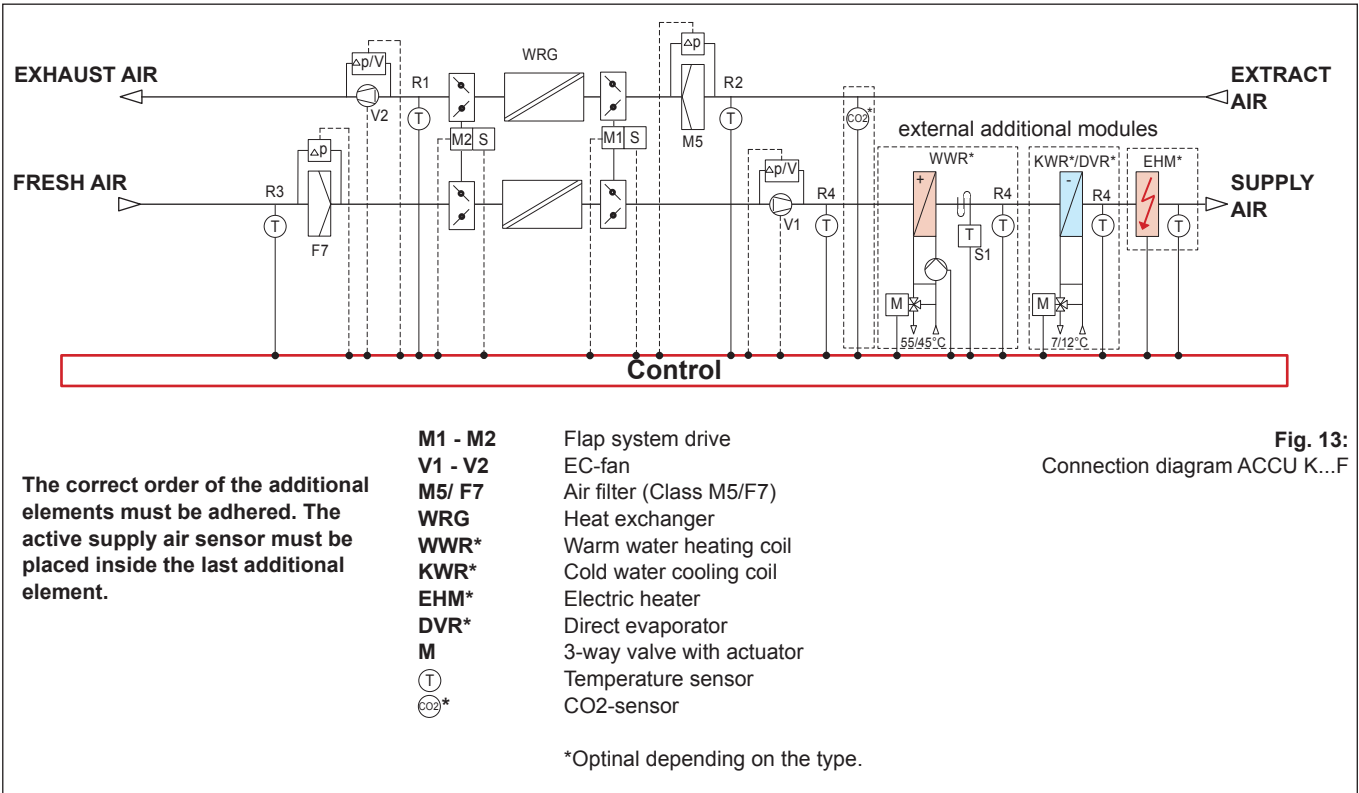

## 9.9. Time / Time switch

### 9.9.1. Setting the current time / day

You can switch from the Operating display to the Selection menu through the „Settings“ icon. Here you have the possibility to set the current time and weekday by pressing „Setting actual time“.

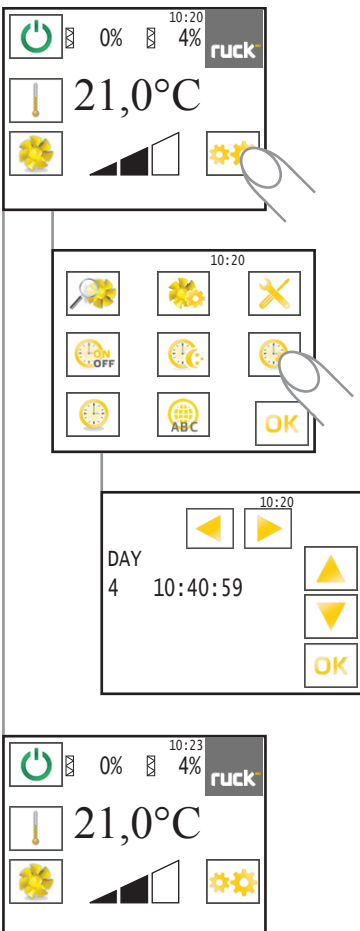

Set	Day
1	Monday
2	Tuesday
3	Wednesday
4	Thursday
5	Friday
6	Saturday
7	Sunday

The display shows the current time and day set.

Under „DAY“ there is a value which shows the current weekday.

When the value is flashing, it can be set. With „▲“ and „▼“, you can set the current weekday (s. table). By touching the icon „►“, you confirm the set value.

On the display, the „hour“ now starts to flash. For setting the hours you can also use the „▲“ and „▼“ icons and then confirm with „►“ or „◀“. You can then set the minutes with „▲“ and „▼“ and then confirm with „►“ or „◀“.

You can go back to the Operating display by touching „OK“.

### 9.9.2. Setting the timer

With the setting parameters for the timer, the times when the unit is to come on (ON) or off (OFF) can be set individually for each day of the week.

You can switch from the Operating display to the Selection menu through the „Settings“ icon. You can access them by selecting „Timer settings“ in the menu for setting the timer.

Set	Day
1	Monday
2	Tuesday
3	Wednesday
4	Thursday
5	Friday
6	Saturday
7	Sunday

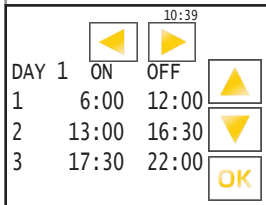
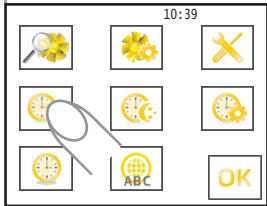
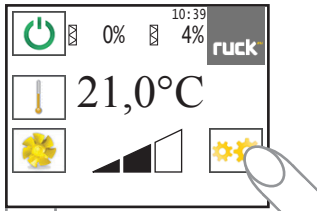

Row (1) flashes on the display, indicating the time when the unit should start on day 1 (Monday) (ON). You can set the hours with „▲“ and „▼“ and then confirm with „▶“. The display then switches to setting the minutes which you can also set with „▲“ and „▼“ and then confirm with „▶“. (The minutes are set in 5-minute increments)

The display now shows flashing of the time when the unit should shut down on day 1 (Monday) (OFF). The setting and confirming of the hours and minutes is done the same way with „▲“ and „▼“ and with „▶“.

You may now set a second period of time for day 1 (Monday) in row (2). Proceed the same way as you did for row (1). If you do not wish to set a second or third period of time, confirm the times 0:00 with „▶“.

After the last item is confirmed for row (3), the display switched to day 2 (Tuesday), for which you can also set the ON and OFF switching times of the unit. Days 3 to 7 then follow.

After you have set all the parameters / days, you go back to the Operating display by clicking „OK“.

However, you do not have to go through the whole timer menu to get back to the status display. You can go back to the Operating display by touching „OK“.

Note:

If the parameters are set with the time 0:00, the unit will not switch on, respectively will not switch off. If, for example, you do not want the unit to switch on during the weekend, then you must set the values 0:00 for day 6 (Saturday) and day 7 (Sunday).

The values set are saved even when there is a power failure or if the battery in the control unit runs down. Only the current time and day of the week have to be reset.

Note: The instructions for changing the battery of the clock are under 7. Battery changing

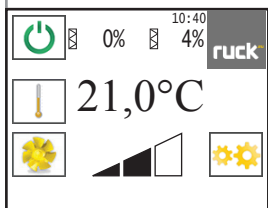

#### 9.9.2.1. Timer on and off switching

The timer can be switched on and off as required.

You can switch from the Operating display to the Selection menu through the „Settings“ icon. By selecting the „Timer“ icon, the timer can be switched on or off.

When the timer is on, a continuous clock symbol is shown on the display.

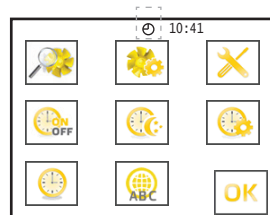
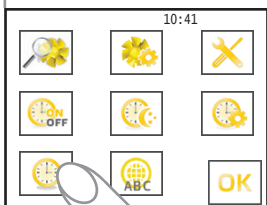
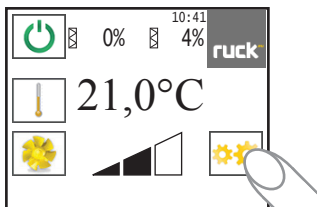

Timer on

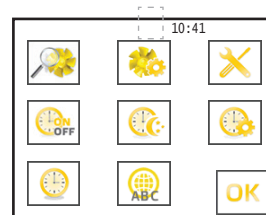

Timer off

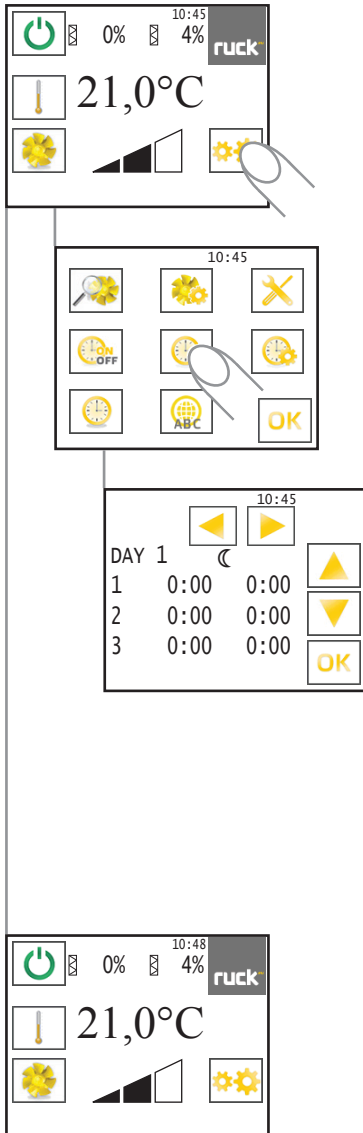

### 9.9.3. Setting day - night switch-over

This menu has the same functions as the timer. The only difference is that the device is not switched on (ON) or off (OFF), but from day to night mode.

The device runs in day mode with the basic ventilation volume flow.

The device runs in night mode with the minimum ventilation volume flow.

You can switch from the Operating display to the Selection menu through the „Settings“ icon. You will access it by selecting „Day/Night“ in the menu for setting the day-night switching.

Set	Day
1	Monday
2	Tuesday
3	Wednesday
4	Thursday
5	Friday
6	Saturday
7	Sunday

Row (1) flashes on the display, indicating the time when the unit should start on day 1 (Monday) (ON). You can set the hours with „▲“ and „▼“ and then confirm with „▶“. The display then switches to setting the minutes which you can also set with „▲“ and „▼“ and then confirm with „▶“.  
(The minutes are set in 5-minute increments)

The display now shows flashing of the time when the unit should quit night mode on day 1 (Monday). The setting and confirming of the hours and minutes is done the same way with „▲“ and „▼“ and with „▶“.

You may now set a second period of time for day 1 (Monday) in row (2). Proceed the same way as you did for row (1). If you do not wish to set a second or third period of time, confirm the times 0:00 with „▶“.

After the last item is confirmed for row (3), the display switched to day 2 (Tuesday), for which you can also set the ON and OFF switching times of the unit. Days 3 to 7 then follow.

After you have set all the parameters / days, you go back to the Operating display by clicking „OK“.

You do not have to go through the entire day-night switching menu in order to go back to the Operating display. You can go back to the Operating display by touching „OK“.

Note:

If the time 0:00 is given in the parameters, the unit will not switch to night operation.

The values set are saved even when there is a power failure or if the battery in the control unit runs down. Only the current time and day of the week have to be reset.

Note: The instructions for changing the battery of the clock are under 7. Battery changing

### 9.9.4. System drawings

**Fig. 14:**  
Systematic drawing without timer settings

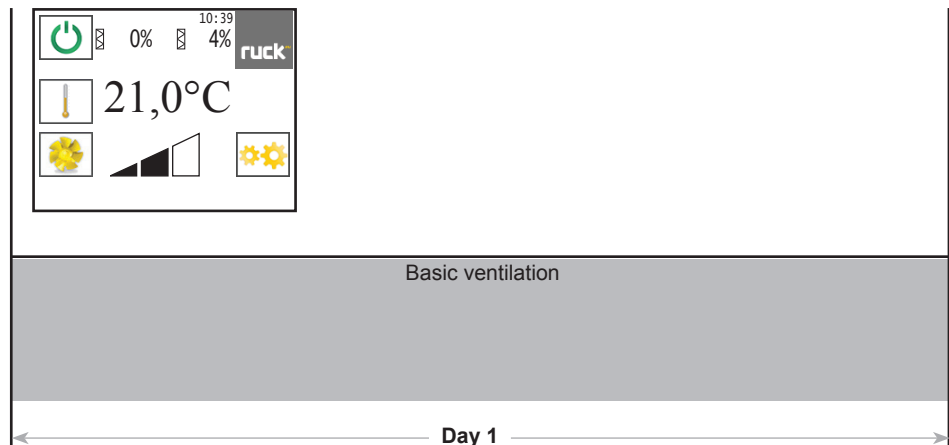

**Fig. 15:**  
Systematic drawing for timer settings

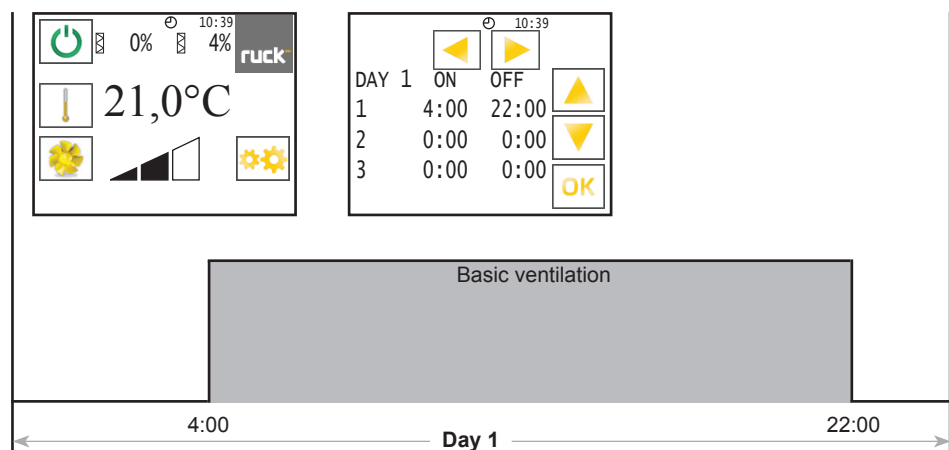

**Fig. 16:**  
Systematic drawing for timer and day-night switch-over settings

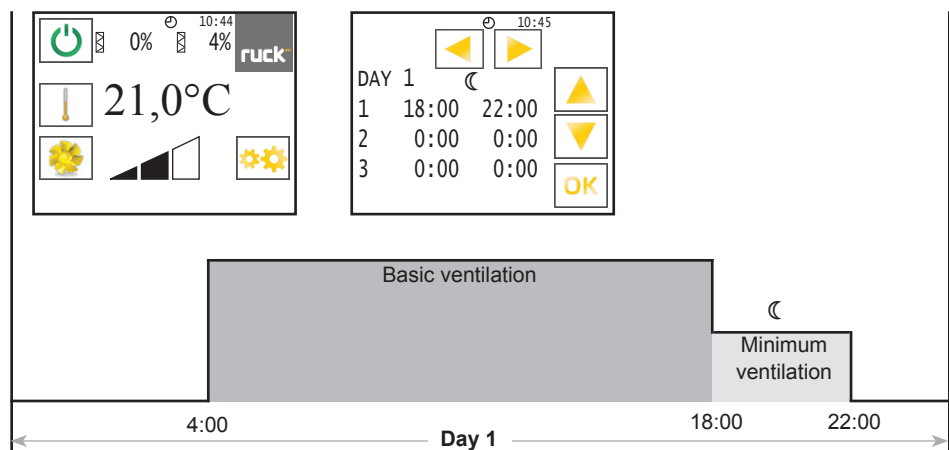

## 9.10. Functions

### 9.10.1. Fan error message contact

Each motor has an error message contact which is closed during fan operation. The unit switches off when the contact opens. After correction of the fault (see 13.2. Fault diagnosis chart), the unit can then be restarted.

If a fault occurs on the fans or EC-controller, the device will switch off and an error message will be displayed. To reset the EC-controller, the electricity supply must be switched off at the main switch for at least 20 s.

### 9.10.2. Version with electric heating coil

The ACCU K can be optionally equipped with the electric heating coil EHM. see description EHM module!

## 10. Maintenance and repair

### 10.1. Important notes



- **Electricity warning (hazardous voltage)!**
- » Failure to observe the hazard may result in death, injury or damage to property.
- Before performing any work on conductive parts, always disconnect the unit completely from the electricity supply and make sure that it cannot be switched back on again.



- **Never reach into the impeller or other rotating or moving parts.**
- » Failure to observe the hazard may lead to serious injury.
- Work may only be performed once the impeller has come to a complete halt.



- **CAUTION! Crushing hazard! Interval switching of the dampers!**
- » Failure to observe the hazard may lead to serious injury.
- Switch off the device by the isolator switch before opening the device.



Maintenance and repairs may only be performed by specialist personnel in accordance with this installation and operating manual and the regulations in force.

Do not repair defective or damaged units yourself, but report the damage or faults to the manufacturer in writing.



- **Unauthorized repairs may cause personal injury and / or damage to property, in which case the manufacturer's guarantee or warranty will not apply.**



### 10.2. Cleaning and care

**Servicing, troubleshooting and cleaning may only be performed by specialist personnel in accordance with this installation and operating manual and the regulations in force.**

If operated correctly, **ruck** products only require a small amount of maintenance. The following work should be performed at regular intervals, in accordance with health and safety regulations:

- Check the operation of the control system and safety devices.
- Check electrical connections and wiring for damage.
- Remove any dirt from the fan impeller or impellers and from inside the fan housing in order to prevent any unbalance or reduction in output.
  - Do not use aggressive or easily flammable products for cleaning (impellers/housing).
  - Preferably only water (not flowing water) or mild suds should be used.
  - The impeller should be cleaned with a cloth or brush.
  - Never use a high-pressure cleaner.
  - Balancing clips must not be moved or removed.
  - The impeller and fittings must not be damaged in any way.
- Check the operation of the bearing with a visual inspection and by checking running noise.
- Check the unit for leaks on the air side.



## 10.3. Maintenance

### 10.3.1. Thermal mass heat exchanger

Thermal mass heat exchanger generally require no maintenance. However, occasionally cleaning of the exchanger is recommended due to hygienic reasons. Damage to the blades should always be avoided. Use warm, flowing water for cleaning.

To properly change the thermal mass heat exchanger, proceed as follows:  
Switch off the device on the control unit.

- Wait until all dampers are closed. (approx. 20 sec)
- Switch off the unit by the isolator switch (1).
- Remove inspection cover (2).
- Remove middle cover (3).
- Remove stiffening plates (4).
- Remove separating plates (5).
- Loosen mounting screws (6) of the tank (A). Attention! Tank can drop out now.
- Repeat procedure for tank (B).
- Rinse tank without pressure with warm water.
- Refit accumulators (A) and (B) and seal
- Mount separating plates (5).
- Mount stiffening plates (4) and middle cover (3).
- Close inspection cover (2).
- Switch isolator switch on (1) and switch the device on by the control unit.

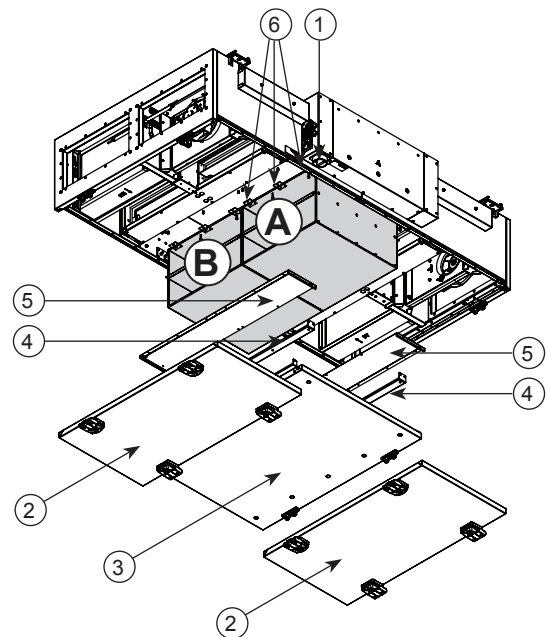

**Fig. 17:**  
Removal thermal mass heat exchanger

### 10.3.2. Air filters

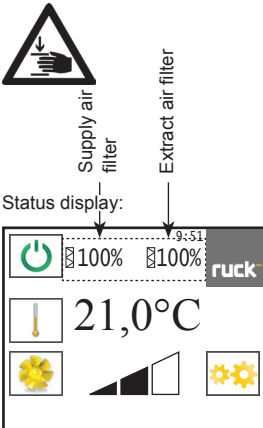

• **CAUTION! Crushing hazard! Interval switching of the dampers!**  
 » Failure to observe the hazard may lead to serious injury.  
 → Switch off the device by the isolator switch before opening the device.

The differential pressure increases as one of the air filters becomes more clogged. When the pressure reaches the value set on the corresponding pressure sensor, this can be seen on the status display. The filter must be changed when the level of clogging reaches 100%. Under P27 FILTER CALIBRATION, the new filter must be calibrated. By touching the icon „▲“, the unit switches to the calibration mode. Display flashes „CALIBRATE FILTER“. After calibration, the display shows „COMPLETED“. The contamination display is set back to 0% after calibration mode. The filter change counter will then increase by one.

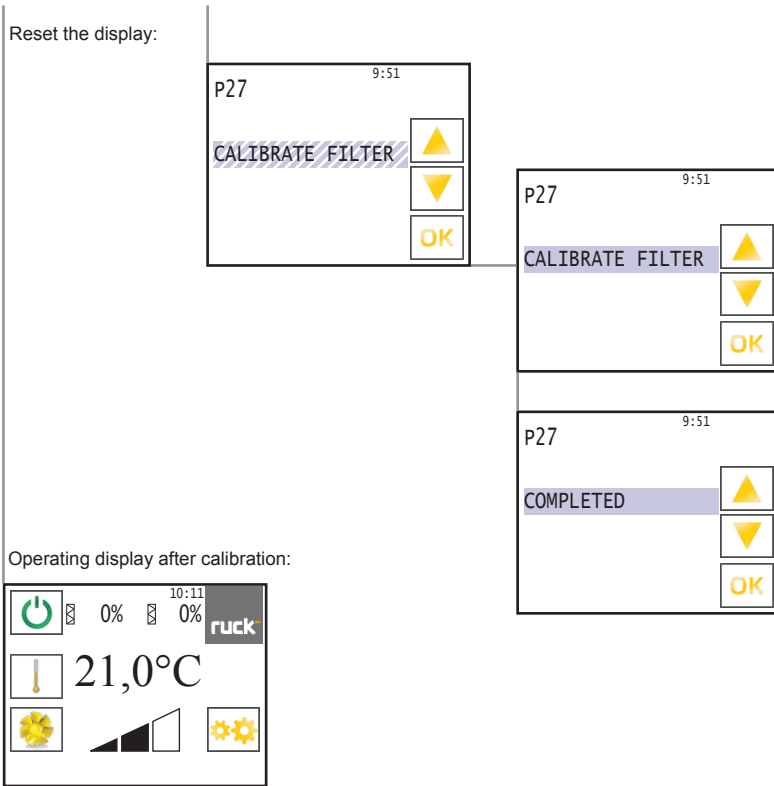

#### Filter change

To ensure that the air filter is changed correctly, proceed as follows:

- Switch off the device on the control unit.
- Wait until all dampers are closed. (approx. 20 sec)
- Switch off the unit by the isolator switch.
- Remove inspection cover.
- The air filter can be removed without the use of tools.
- The air filter should be replaced if severely clogged.
- When changing the filter, make sure that the filter frame is sitting correctly on the guide rail in the device.
- Mount inspection cover.
- Switch isolator switch on.
- Switch unit on.
- Then the filter display must be reset and the new air filter calibrated.

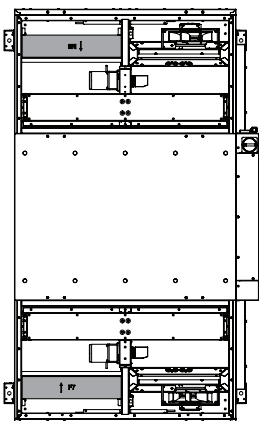

Fig. 18:  
Position air filter

### 10.3.3. Changing the battery

The battery's operating capacity is checked when voltage is applied to the unit. An empty battery is indicated by a battery symbol in the status display.

Change the battery as follows:

- Remove the control cable (1) from the control unit.
- Open the control unit by removing the cover (2).
- The holder (3) for the battery is on the board. Take the battery out and replace it with a new one, as shown in the image.
- The control unit can now be closed again and the control cable connected again.
- You only have to reset the current time. The battery symbol disappears from the status display. Your control unit is fully functional again.

*Note: requires a 3 V lithium CR 1616 button cell battery.*

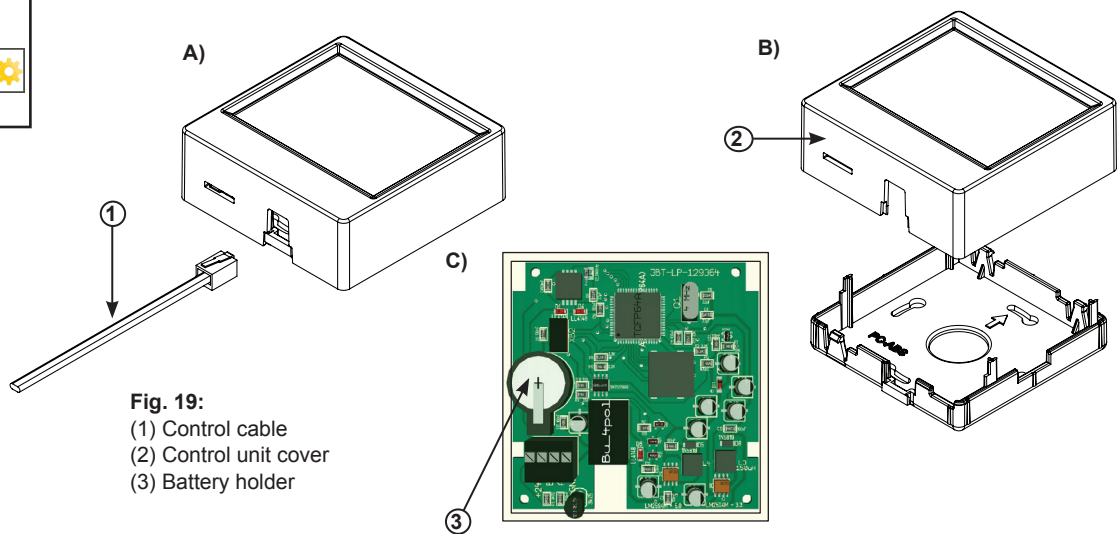
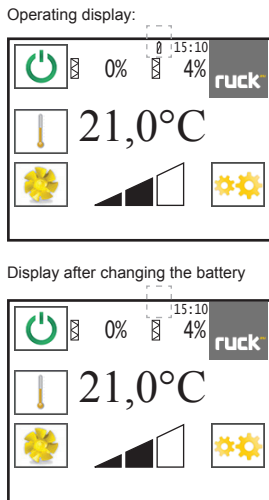

## 11. Modbus communication interface

### 11.1. Wiring diagram

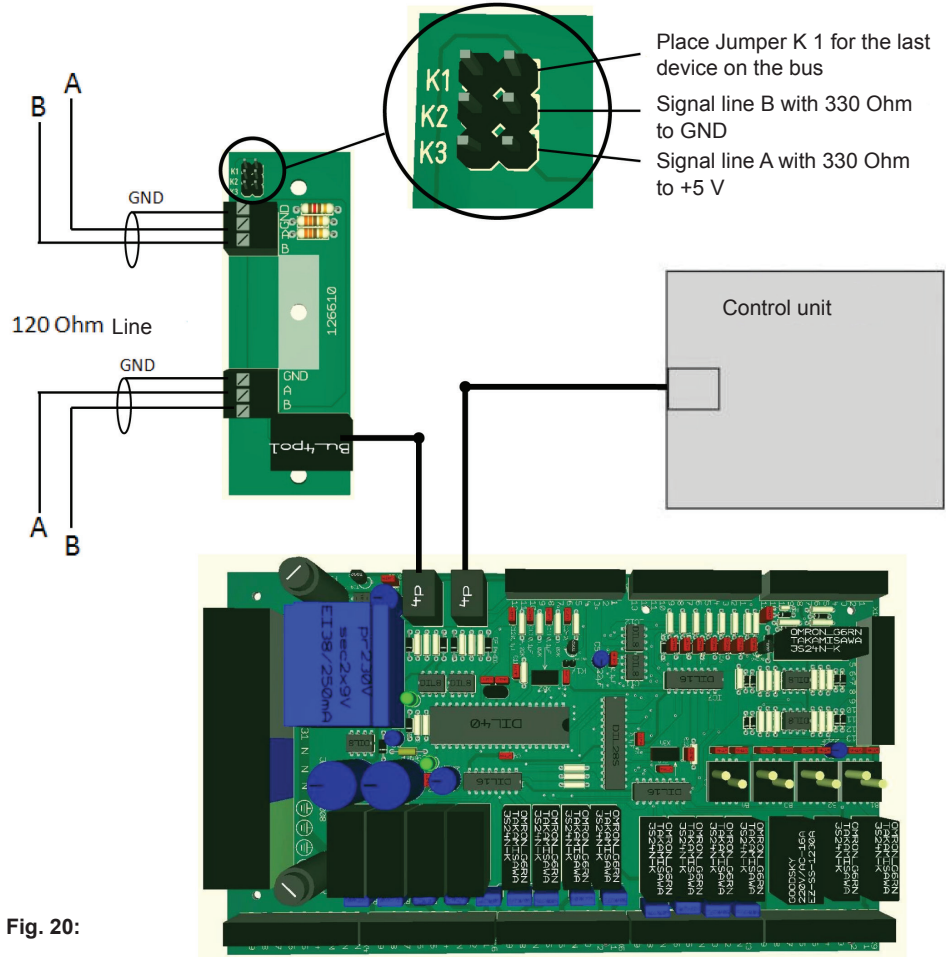

Fig. 20:

### 11.2. Interface information

The device works as a Modbus RTU slave. The interface configuration is 8N1, 9600Baud, slave address 1. The address and the baud rate can be set via parameters P7 and P8. As bus line is recommended a twisted pair data cable with 120 Ohm impedance.

### 11.3. Functions implemented

Function code	Name	Description
03 Hex	Read Hold Register	Read device parameter
04 Hex	Read Input Register	Read current value
06 Hex	Write Single Register	Write device parameter word by word
10 Hex	Write Multiple Register	Write several device parameters word by word

Function code	Name	Sub-function	Description
08 Hex	Return Query Dat	00	Send the received message back
08 Hex	Restart Communications	01	Restart communication
08 Hex	Force Listen Only Mode	04	Switch to listen-only mode

### 11.4. Parameter table

Register address	Protocol address	Parameter name	Value range	Data type	Authority
40001	0	Reserved		integer	R/W
40002	1	Minimum target temperature	100 - 200 corresponds to 10.0 - 20.0 °C	integer	R/W
40003	2	Maximum target temperature	200 - 350 corresponds to 20.0 - 35.0 °C	integer	R/W
40004	3	External error input	0 = Automatic start 5 = Start after acknowledgement	integer	R/W
40005	4	I - component of heating controller	5 - 20 5 = 0.5 min 20 = 2 min	integer	R/W
40006	5	P - component of heating controller	5 - 20	integer	R/W
40007	6	Temperature-correction sensor	-50 - +50 corresponds to -5.0 -+5.0 °C	integer	R/W
40008	7	Modbus address	1 - 247	integer	R/W
40009	8	Modbus baud rate	0=2400 ; 1=4800 ; 2=9600 ; 3=14400 Baud ; 4=19200	integer	R/W
40010	9	Reserved		integer	R/W
40011	10	Reserved		integer	R/W
40012	11	Reserved		integer	R/W
40013	12	Reserved		integer	R/W
40014	13	Units	0 = Air volume control 1 = Pressure control 2 = Supply air pressure control Extract air volume control	integer	R/W
40015	14	External sensor type	0 = Constant air volume 1 = CO2 sensor 2 = VOC sensor 3 = Humidity sensor 4 = External control	integer	R/W
40016	15	Minimum ventilation supply air	See Table below or 50 - 500 Pa	integer	R/W
40017	16	Minimum ventilation extract air	See Table below or 50 - 500 Pa	integer	R/W
40018	17	Basic ventilation supply air	See Table below or 50 - 500 Pa	integer	R/W
40019	18	Basic ventilation extract air	See Table below or 50 - 500 Pa	integer	R/W
40020	19	Intermittent ventilation supply air	See Table below	integer	R/W
40021	20	External set-point (CO2, VOC, humidity)	CO2/VOC Range of values 600 - 1500PPM Humidity Range of values 20% - 90%	integer	R/W
40022	21	Type of regulation	0 = Room temperature 1 = Supply-air temperature 2 = Outlet-air temperature	integer	R/W
40023	22	Function (heating – cooling coil)	0 = Heating (Water) 1 = Cooling (Water) 2 = Heating and cooling (Water) 3 = Heating water and cooling direct expansion	integer	R/W
40024	23	Min. value when analogue input 0V external sensor	0 - 500 for CO2 and VOC sensor 0 - 50 for humidity sensor	integer	R/W
40025	24	Max. value when analogue input 10V external sensor	0 - 5000 for CO2 and VOC sensor 0 - 100 for humidity sensor	integer	R/W
40026	25	Sensor contamination filter 1	0 - 500 Pa Pressure loss	integer	R/W
40027	26	Sensor contamination filter 2	0 - 500 Pa Pressure loss	integer	R/W
40028	27	Calibrate filter	1 = Calibrate filter	integer	R/W
40029	28	Intermittent ventilation extract air	See Table below	integer	R/W
40030	29	Reserved		integer	R/W
40031	30	Follow-up time motion detector	60 - 3600 sec	integer	R/W
40032	31	Target temperature	Minimum - maximum target temperature in 1/10 degree	integer	R/W
40033	32	Ventilation change-over	1 = Basic ventilation 2 = Minimum ventilation	integer	R/W
40034	33	Status and control word	See Table below	integer	R/W
40035	34	Reserved		integer	R/W
40036	35	Save parameters	12439 Value change after saving under 0	integer	R/W

Register address	Parameter name	Value range		
		ACCU K 600 F	ACCU K 1200 F	ACCU K 2400 F
40016	Minimum ventilation supply air	200 - 600 m <sup>3</sup> /h	400 - 1200 m <sup>3</sup> /h	400 - 1200 m <sup>3</sup> /h
40017	Minimum ventilation extract air	200 - 600 m <sup>3</sup> /h	400 - 1200 m <sup>3</sup> /h	400 - 1200 m <sup>3</sup> /h
40018	Basic ventilation supply air	200 - 600 m <sup>3</sup> /h	400 - 1200 m <sup>3</sup> /h	400 - 1200 m <sup>3</sup> /h
40019	Basic ventilation extract air	200 - 600 m <sup>3</sup> /h	400 - 1200 m <sup>3</sup> /h	400 - 1200 m <sup>3</sup> /h
40020	Intermittent ventilation supply air	200 - 600 m <sup>3</sup> /h	400 - 1200 m <sup>3</sup> /h	400 - 1200 m <sup>3</sup> /h
40029	Intermittent ventilation extract air	200 - 600 m <sup>3</sup> /h	400 - 1200 m <sup>3</sup> /h	400 - 1200 m <sup>3</sup> /h

### Status and control word, protocol address 33

Function	Authority	Comment
Bit 0 1 = Error present	R	
Bit 1 1 = Pre-heating mode	R	
Bit 2 Reserved	R	
Bit 3 Reserved		
Bit 4 Filter changed	R/W	With rising slope, filter change acknowledged
Bit 5 1 = Cancel error	R/W	With rising slope, error is cancelled
Bit 6 0 = Unit switched ON 1 = Unit switched OFF	R/W	shut-off with increasing flank
Bit 7 1 = Unit switched ON 0 = Unit switched OFF	R/W	With rising slope, unit switched ON
Bit 8 E-heating module 1	R	1 = present 0 = not present
Bit 9 E-heating module 2	R	1 = present 0 = not present
Bit 10 Reserved	R/W	
Bit 11 Reserved	R/W	
Bit 12 Reserved	R/W	
Bit 13 Reserved	R/W	
Bit 14 Reserved	R/W	
Bit 15 Reserved	R/W	

### 11.5. Current value table

Register address	Protocol address	Parameter name	Value range	Data type	Authority
30001	0	Unit identification	8000	integer	R
30002	1	Room temperature	Temp in 1/10 ° - 500 to 1000	integer	R
30003	2	Supply-air temperature	Temp in 1/10 ° - 500 to 1000	integer	R
30004	3	Outlet-air temperature	Temp in 1/10 ° - 500 to 1000	integer	R
30005	4	Exhaust-air temperature	Temp in 1/10 ° - 500 to 1000	integer	R
30006	5	Outdoor-air temperature	Temp in 1/10 ° - 500 to 1000	integer	R
30007	6	Pressure-difference, filter 1	0 - 1000 Pa	integer	R
30008	7	Pressure-difference, filter 2	0 - 1000 Pa	integer	R
30009	8	Soiling indicator 1	0 - 100%	integer	R
30010	9	Soiling indicator 2	0 - 100%	integer	R
30011	10	Program version	0 - 100	integer	R
30012	11	Operating hours	(0 - 32767) *10	integer	R
30013	12	Number of filter changes	0 - 32767	integer	R
30014	13	Inputs	See Table below	integer	R
30015	14	Outputs	See Table below	integer	R
30016	15	Volumetric flow supply air in m <sup>3</sup> /h		integer	R
30017	16	Volumetric flow extract air in m <sup>3</sup> /h		integer	R
30018	17	Supply air efficiency in %		integer	R
30019	18	Extract air efficiency in %		integer	R
30020	19	Used by system		integer	R
30021	20	Used by system		integer	R
30022	21	Valve setting, heating valve	0 - 100%	integer	R
30023	22	Valve setting, cooling valve	0 - 100%	integer	R
30024	23	Actual sensor value	0-2000 ppm / 0-100 % Humidity	integer	R
30025	24	Error number	See Table below	integer	R
30026	25	Reserved		integer	R
30027	26	Pressure supply air analogue input 2		integer	R
30028	27	Pressure extract air analogue input 3		integer	R
30029	28	Reserved		integer	R
30030	29	Reserved		integer	R

### Current value table, protocol addresses 13 (inputs) ACCU K

Bit 0	1 = Enable_signal_external
Bit 1	1 = Fan motor electronic ok
Bit 2	1 = Thermal switch, fan
Bit 3	1 = Frost protection OK
Bit 4	Motion detector
Bit 5	Fire detector
Bit 6	Damper end switch M2
Bit 7	Damper end switch M1
Bit 8	Damper end switch M3

### Current value table, protocol addresses 14 (outputs) ACCU K

Bit 0	Reserved
Bit 1	Reserved
Bit 2	1 = Cooling requirement
Bit 3	Reserved
Bit 4	Reserved
Bit 5	1 = Heating valve open
Bit 6	1 = Heating valve closed
Bit 7	1 = Heating pump on
Bit 8	1 = Unit defective
Bit 9	Reserved
Bit 10	Antifreeze heater
Bit 11	1 = Cooling valve open
Bit 12	1 = Cooling valve closed
Bit 13	M3 Damper outside
Bit 14	M1 Damper supply air
Bit 15	M2 Damper extract air

### Current value table, protocol addresses 24 (error numbers) ACCU K

Value	
0	No error
1	Supply-air temperature sensor defective
2	Room-air temperature sensor defective
3	Outlet-air temperature sensor defective
4	Exhaust-air temperature sensor defective
5	Outdoor-air temperature sensor defective
6	Damper position
7	Frost protection triggered
8	Safety thermostat triggered
9	Thermal switch for ventilator triggered
10	Fan defective
11	Reserved
12	Not enabled
13	Cooling plant defective
14	Fire detector
15	Reserved
16	Reserved
17	Supply-air temperature too low
18	Supply-air temperature too hot
19	Reserved
20	Heat exchanger

## 12. Dismantling and disposal



- **Risk of injury if dismantled under hazardous voltage!**
- » **If you do not switch off the voltage before starting to dismantle the unit, you may injure yourself and damage the product or parts of the installation.**
- **Make sure that the relevant parts of the installation have been disconnected from the voltage supply.**

Dismantle the unit as follows:



### 12.1. Disassembling the product

Observe the safety instructions given in Sections 2 to 8 and Section 12 when decommissioning and disassembling the unit.

### 12.2. Disposal

Careless disposal of the unit may cause pollution. Please therefore dispose of the unit in accordance with the national requirements that apply in your country.

## 13. Troubleshooting

Please note the following instructions:

- Proceed systematically and purposefully when troubleshooting, even when under the pressure of time. In the worst case, randomly and indiscriminately dismantling and changing settings may result in it no longer being possible to determine the original cause of the fault.
- Get an overview of the unit's operation in conjunction with the overall installation.
- Try to clarify whether the unit provided the required function in the overall installation before the fault occurred.
- Try to find any changes to the overall installation in which the unit is installed:
  - Have the unit's operating conditions or operating range been changed?
  - Have any changes (e.g. reconfigurations) or repairs been performed on the overall system (installation, electrics, control) or to the unit? If yes: what?
  - Has the unit been operated correctly?
  - How does the fault appear?
- Form a clear idea of the cause of the fault. If necessary, question the immediate operator or the installation operator.

If you have not been able to remove the fault, please contact the manufacturer. The contact address can be found at [www.ruck.eu](http://www.ruck.eu) or on the back cover of this assembly and operating manual.



### 13.1. Low-current fuses

There are two low-current fuses built-in at the controller circuit board to protect the electrical equipment. If the fuse blows, the fault can be located and repaired by using the following table. A low-current fuse must be changed by specialist personnel. The low-current fuses must comply with EN 60127, dimensions 5 x 20 mm.

Fuse	Possible causes	Fault correction
<b>F1 / T 0,25 A</b>	<ul style="list-style-type: none"> <li>• Control unit defect.</li> <li>• Connecting lead defect.</li> <li>• Board on control unit dragged.</li> <li>• Mainboard defect.</li> <li>• Mainboard dragged.</li> </ul>	<ul style="list-style-type: none"> <li>• Replace control unit.</li> <li>• Replace connecting lead.</li> <li>• Clean board with appropriate means.</li> <li>• Inform Service</li> <li>• Inform Service</li> </ul>
<b>F2 / T 6,3 A</b>	<ul style="list-style-type: none"> <li>• Valve gear and cable defect.</li> <li>• Circulating pump and cable defect.</li> <li>• Damper drive and cable defect.</li> </ul>	<ul style="list-style-type: none"> <li>• Replace valve gear and cable.</li> <li>• Replace circulating pump and cable.</li> <li>• Replace damper drive and cable.</li> </ul>

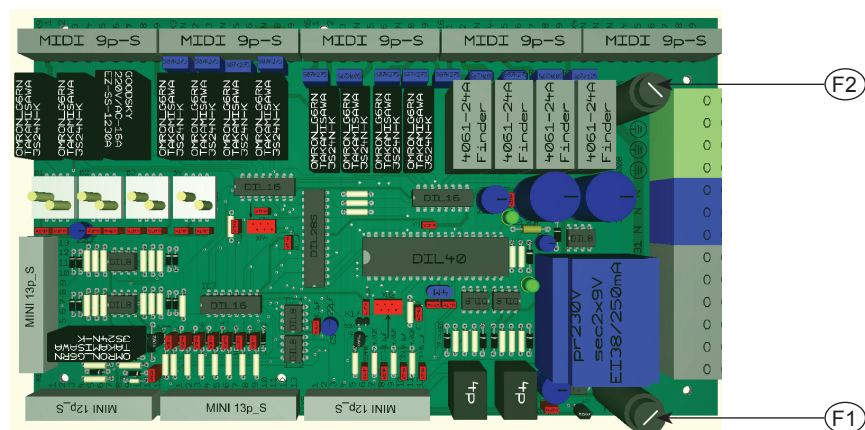
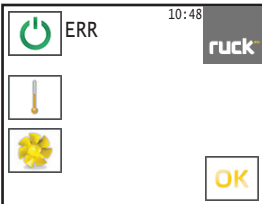
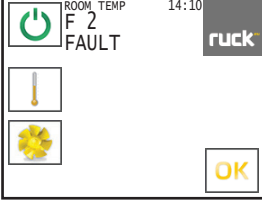
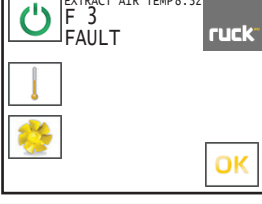
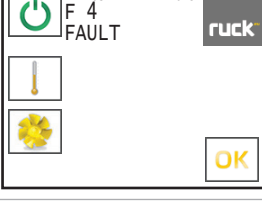

Fig. 21: Position low-current fuse

### 13.2. Fault diagnosis chart

If a fault occurs on the unit, one or more fault messages will appear on the display. The error is acknowledged with the „OK“ button. It is not possible to use the control unit until all of the faults have been removed and acknowledged. Depending on the priority of the fault, the installation will either switch off or continue working with the last settings.

The following faults might be shown on the display:

Faults displayed	Type of fault and repair
	<b>Battery</b> <ul style="list-style-type: none"> <li>» Battery of the remote control unit is empty</li> <li>» Replace battery</li> </ul>
	<b>ERROR</b> <ul style="list-style-type: none"> <li>» The control unit has no connection.</li> <li>» Check the connection or replace the cable if necessary.</li> </ul>
	<b>Supply air temperature sensor fault</b> <ul style="list-style-type: none"> <li>» The supply air temperature sensor is defective or the cable is broken.</li> <li>» Replace the defective temperature sensor or replace the broken cable if necessary.</li> <li>» After the failure reason is remedied, the failure must be confirmed with „OK“.</li> </ul>
	<b>Room temperature sensor fault.</b> <ul style="list-style-type: none"> <li>» The room temperature sensor malfunctions.</li> <li>» Replace the remote control unit.</li> <li>» After the failure reason is remedied, the failure must be confirmed with „OK“.</li> </ul>
	<b>Extracted air temperature sensor fault.</b> <ul style="list-style-type: none"> <li>» The extracted air temperature sensor is defective or the cable is broken.</li> <li>» Replace the defective temperature sensor or replace the broken cable if necessary.</li> <li>» After the failure reason is remedied, the failure must be confirmed with „OK“.</li> </ul>
	<b>Exhaust air temperature sensor fault.</b> <ul style="list-style-type: none"> <li>» The exhaust air temperature sensor is defective or the cable is broken.</li> <li>» Replace the defective temperature sensor or replace the broken cable if necessary.</li> <li>» After the failure reason is remedied, the failure must be confirmed with „OK“.</li> </ul>
	<b>Outside air temperature sensor fault.</b> <ul style="list-style-type: none"> <li>» The outside air temperature sensor is defective or the cable is broken.</li> <li>» Replace the defective temperature sensor or replace the broken cable if necessary.</li> <li>» After the failure reason is remedied, the failure must be confirmed with „OK“.</li> </ul>

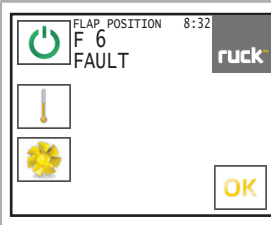
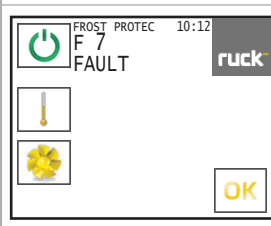
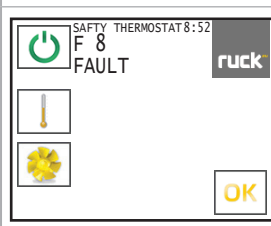
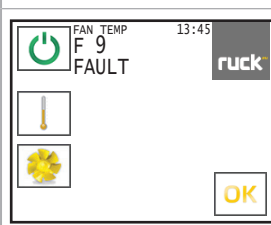
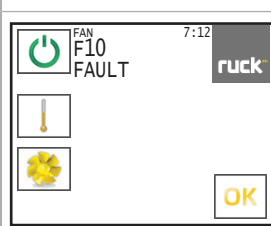
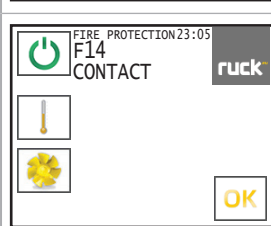
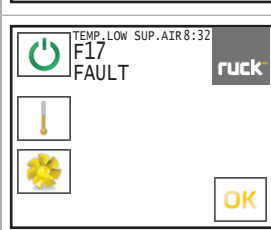
Faults displayed	Type of fault and repair
	<p><b>Damper position error</b></p> <ul style="list-style-type: none"> <li>» Incorrect damper position.</li> <li>» Damper actuator or sensor cable defective.</li> <li>» After the failure reason is remedied, the failure must be confirmed with „OK“.</li> </ul>
	<p><b>Error frost protection</b></p> <ul style="list-style-type: none"> <li>» The air temperature has fallen below the value set on the antifreeze thermostat. The fans will be switched off, the air flaps closed, the heating valve fully opened and the circulating pump switched on.</li> <li>» Check fuse F2.</li> <li>» After the failure reason is remedied, the failure must be confirmed with „OK“.</li> </ul>
	<p><b>Fault in the safety thermostat - electric heating element temperature monitoring</b></p> <ul style="list-style-type: none"> <li>» The housing temperature is higher than 75 °C. The control circuit is broken, the electric heater is switched off. Possible cause: defective supply air valve, fan has failed, etc.</li> <li>» Repair supply air valve, check fuses F2.</li> <li>» After the failure reason is remedied, the reset button of the safety thermostat has to be reset manually, and the failure has to be confirmed at the control unit with „OK“.</li> </ul>
	<p><b>Fault, fan thermal contact</b></p> <ul style="list-style-type: none"> <li>» The thermal contact has been tripped, device will be switched off. Possible cause: motor overheating or defective.</li> <li>» The power supply must be switched off at the main switch for at least 20 s. Check fuse F2, replace the motor if necessary.</li> <li>» After the failure reason is remedied, the failure must be confirmed with „OK“.</li> </ul>
	<p><b>Error fan</b></p> <ul style="list-style-type: none"> <li>» A signalling relays of a fan has been tripped.</li> <li>» Switch the unit off, check wiring and fans and if needed, replace damaged fan.</li> <li>» After the failure reason is remedied, the failure must be confirmed with „OK“.</li> </ul>
	<p><b>Fire protection signal</b></p> <ul style="list-style-type: none"> <li>» The fire protection contact is open. The fire detector has tripped.</li> <li>» After the fire detection has been remedied, you have to confirm with „OK“.</li> </ul>
	<p><b>Insufficient temperature of supply air</b></p> <ul style="list-style-type: none"> <li>» The maximum set supply air temperature (12 °C) was undershot longer than 30 minutes.</li> <li>» After the failure reason is remedied, the failure must be confirmed with „OK“.</li> </ul>

Faults displayed	Type of fault and repair
	<p><b>Excess temperature, supply air</b></p> <ul style="list-style-type: none"> <li>» The maximum supply air temperature of 80 °C was exceeded longer than 10 sec. or the cable of the air supply temperature sensor is broken.</li> <li>» Switch off the device, check fans.</li> <li>» After the failure reason is remedied, the failure must be confirmed with „OK“.</li> </ul>
	<p><b>No release</b></p> <ul style="list-style-type: none"> <li>» The release contact is not closed.</li> <li>» Close the release contact. The unit can then be started.</li> </ul>

**14. Technical data**

Technical data			ACCU K 600 F OOJR ACCU K 600 F OOJL	ACCU K 1200 F OOJR ACCU K 1200 F OOJL	ACCU K 2400 F OOJR ACCU K 2400 F OOJL
Units / Model					
ID			142491 143043	145767 145765	147192 148621
Length	<i>L</i>	<i>mm</i>	1800	2200	2200
Width	<i>B</i>	<i>mm</i>	960	1460	1890
Height	<i>H</i>	<i>mm</i>	365	485	485
Duct connection		<i>mm</i>	400 x 200	600 x 300	700 x 300
Weight		<i>kg</i>	198,0	363,0	420,0
Operating voltage		<i>V</i>	230V ~	230V ~	400V 3~N
Frequency		<i>Hz</i>	50	50	50
Power consumption		<i>W</i>	380	605	1950
Maximum current		<i>A</i>	2,9	4,2	4,0
Pre-fuse		<i>A</i>	16	16	3 x 16
Max. ambient temp.		<i>°C</i>	40	40	40
Max. air volume		<i>m³/h</i>	760	1460	3050
RPM		<i>1/min</i>	4300	3010	3390
Max. primary static pressure		<i>Pa</i>	1030	840	1320
Sound power level supply air	<i>L<sub>WA6</sub></i>	<i>dB(A)</i>	82	81	93
Sound power level extract air	<i>L<sub>WA5</sub></i>	<i>dB(A)</i>	58	63	66
Sound power level outdoor air	<i>L<sub>WA5</sub></i>	<i>dB(A)</i>	57	63	66
Sound power level exhaust air	<i>L<sub>WA6</sub></i>	<i>dB(A)</i>	82	82	88
Sound power level casing	<i>L<sub>WA2</sub></i>	<i>dB(A)</i>	57	59	63
Wiring diagrams No.			143169	146098	146099

**Fig. 22:**  
Dimensions of the supply air unit

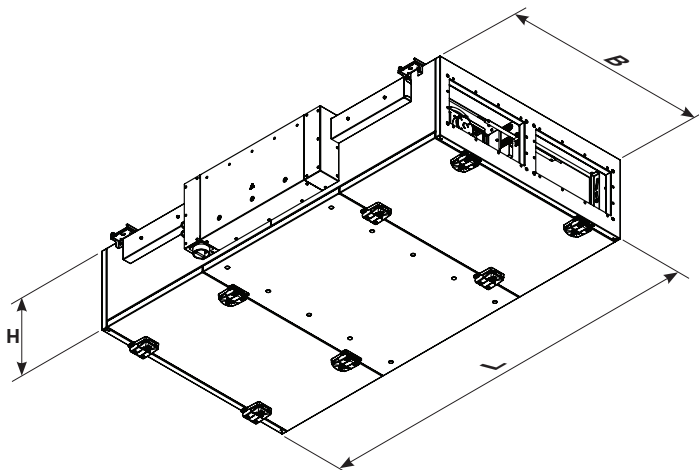

**Fig. 23:**  
Outside dimensions of the control unit.

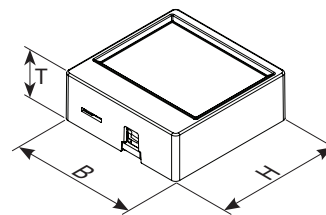

**Fig. 24:**  
Installation dimensions of the control unit.

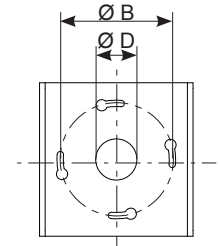

Control unit			
Size	<i>B+H+T</i>	<i>mm</i>	82+82+30
Assembly size	<i>Ø B</i>	<i>mm</i>	60
	<i>Ø D</i>	<i>mm</i>	22



## 15. Appendix

### 15.1. List of parameters

The following table lists all of the parameters that are displayed on the control unit, some of which may be changed. The section 9.7. „Parameter settings menu“ gives full instructions on operating and setting the corresponding parameters.

No.	Consequence	Range of values	Factory setting
P 1	Mini.set-point temp. that can be set on the control unit	10 °C ... 20 °C	16 °C
P 2	Max. set-point temp. that can be set on the control unit	20 °C ... 35 °C	22 °C
P 3	External release	AUTOMATED ACKNOWLEDGED	AUTOMATED
P 4	I - component	5 ... 20	10
P 5	P - component	5 ... 20	10
P 6	Temp. correction of the ambient temp. sensor on the control unit	-5 °C ... 5 °C	0
P 7	Address	1 - 247	1
P 8	Baud rate	2400 / 4800 / 9600 / 14400 / 19200	9600
P 13	Type	V / PV / P	V
P 14	Sensor type	CO2 / VOC / HUMIDITY	Units / Model
P 15	Minimum ventilation supply air		
P 16	Minimum ventilation extract air		
P 17	Basic ventilation supply air		
P 18	Basic ventilation extract air		
P 19	Intermittent ventilation supply air		
P 28	Intermittent ventilation extract air		
P 20	Air quality	CO2 / VOC / r.F	1400 ppm / 45 %
P 21	Type of regulation	SUP.AIR TEMP.CON / ETA TEMP.CTRL / ROOMTEMP.CONTROL	SUP.AIR TEMP.CON
P 22	Selection of heating system	HEATING / COOLING / HEATING-COOLING DIRECT EVAPORATO	HEATING
P 23	Sensor measuring range min.	0 ppm / 0 %	
P 24	Sensor measuring range max.	2000 ppm / 100 %	
P 25	Supply air filter	0 - 500 Pa	100 Pa
P 26	Extract air filter	0 - 500 Pa	100 Pa
P 27	Calibrate filter		
P 30	Extended running time	1 - 60 min	5 min

15.2. Technical drawings

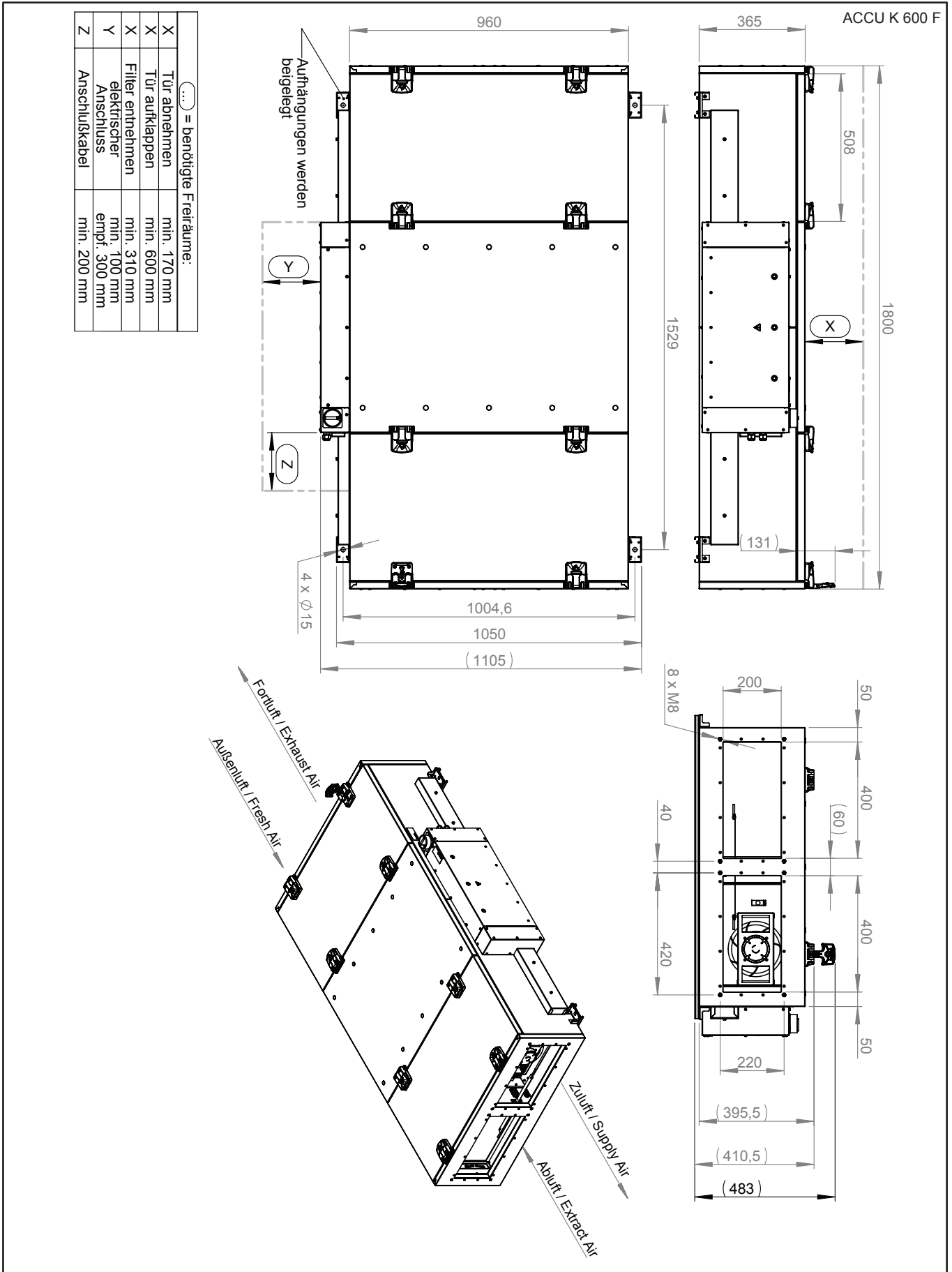

ACCU K 1200 F

X	Tür abnehmen	min. 170 mm
X	Tür aufklappen	min. 700 mm
X	Filter entnehmen elektrischer Anschluss	min. 400 mm min. 100 mm empf. 300 mm
Y	Anschlusskabel	min. 200 mm

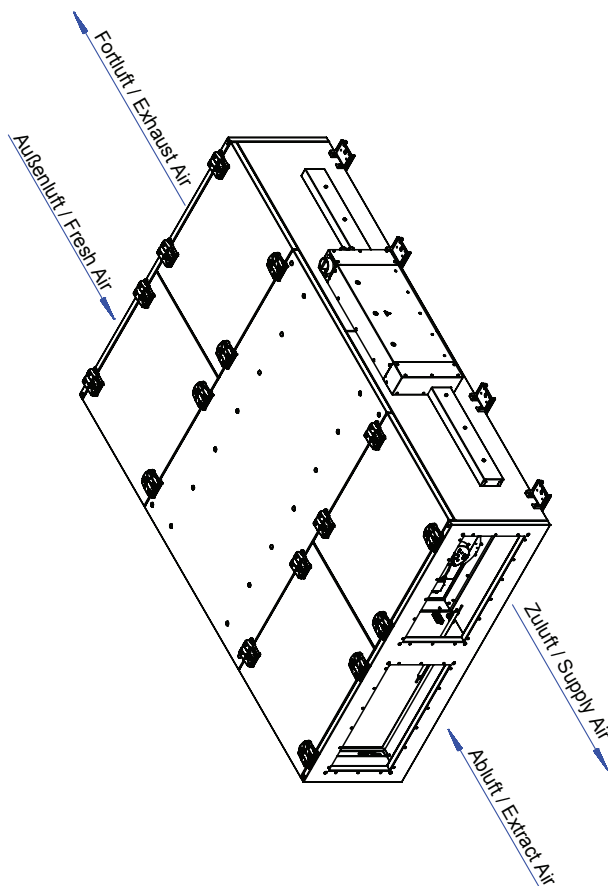
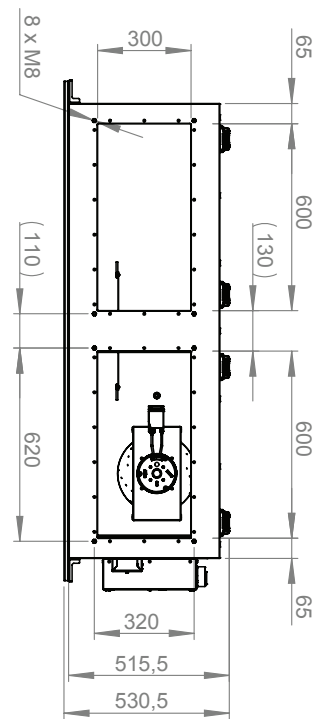
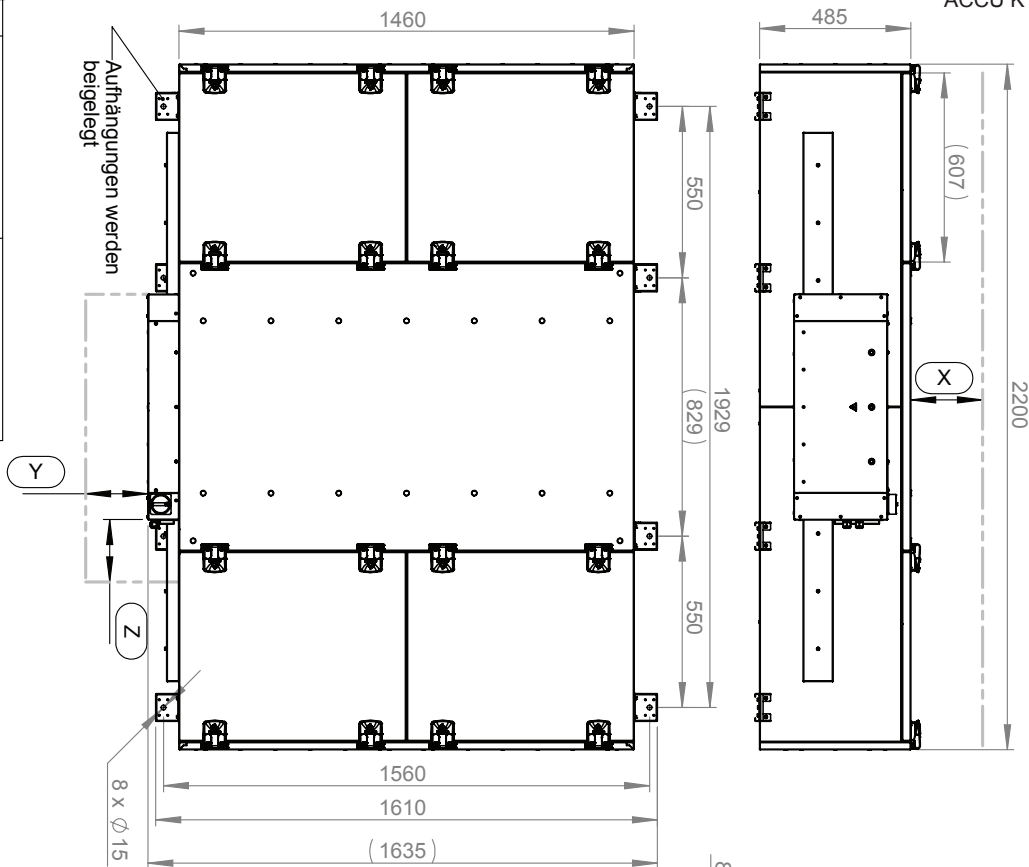

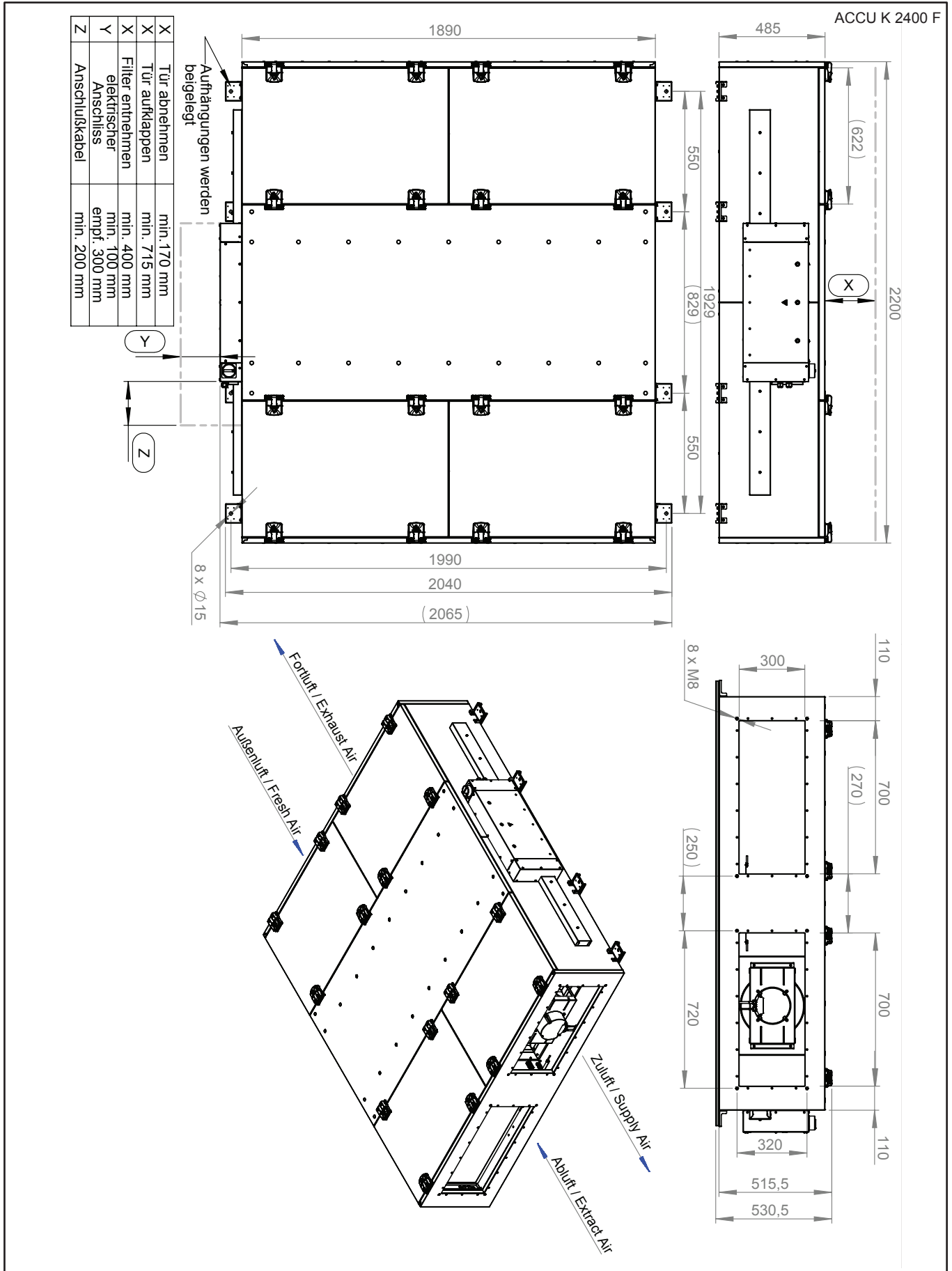



### 15.3. Wiring diagram

**ACCU K 600** Wiring diagram No.: 143169 Part 1

Netzspannung : 230V / 1~ / N / 50Hz  
 Mains voltage

Steuerspannung : 24V DC  
 control voltage

Vorsicherung : 16A  
 Fuse

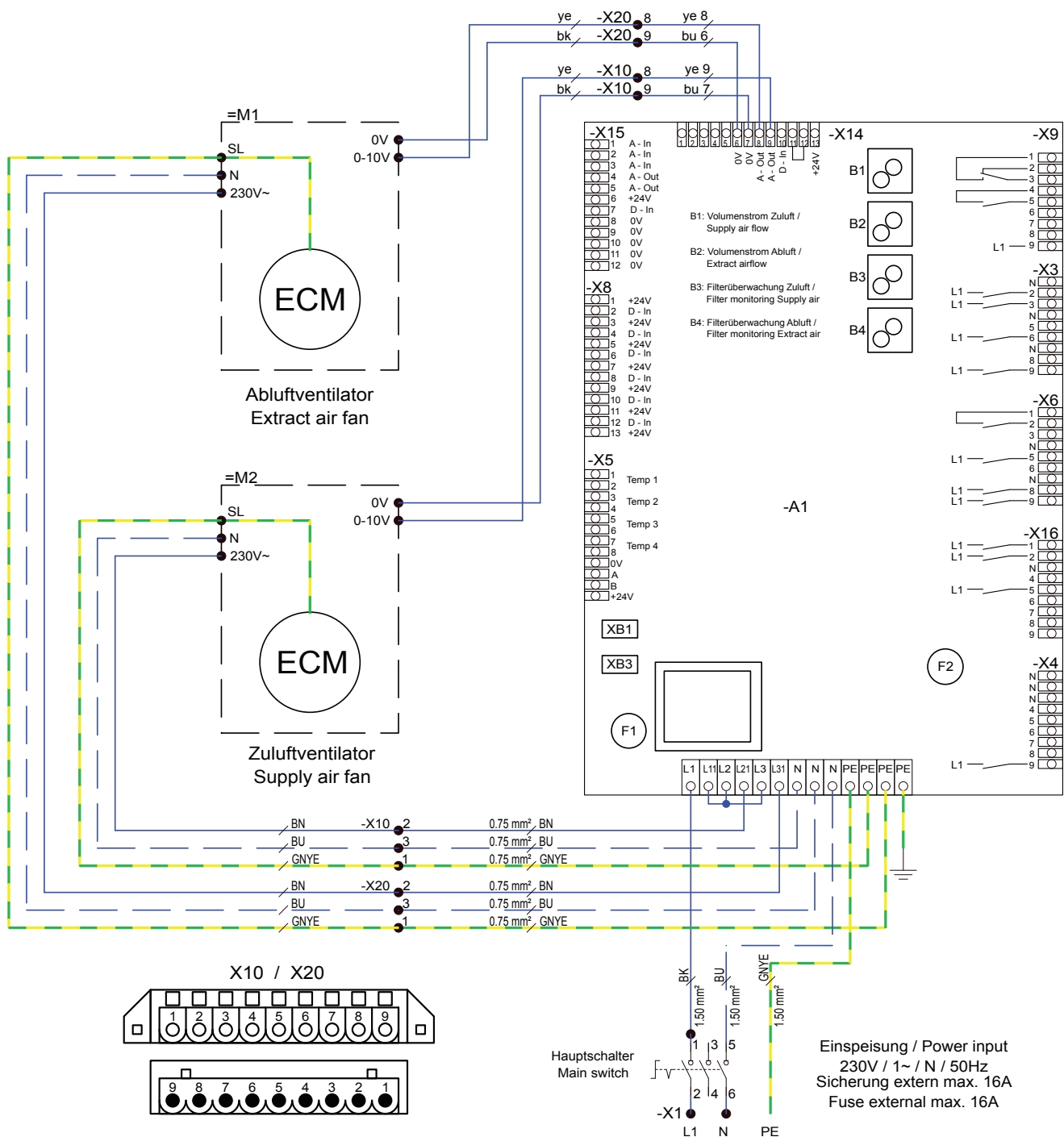

ACCU K 600 Wiring diagram No.: 143169 Part 2

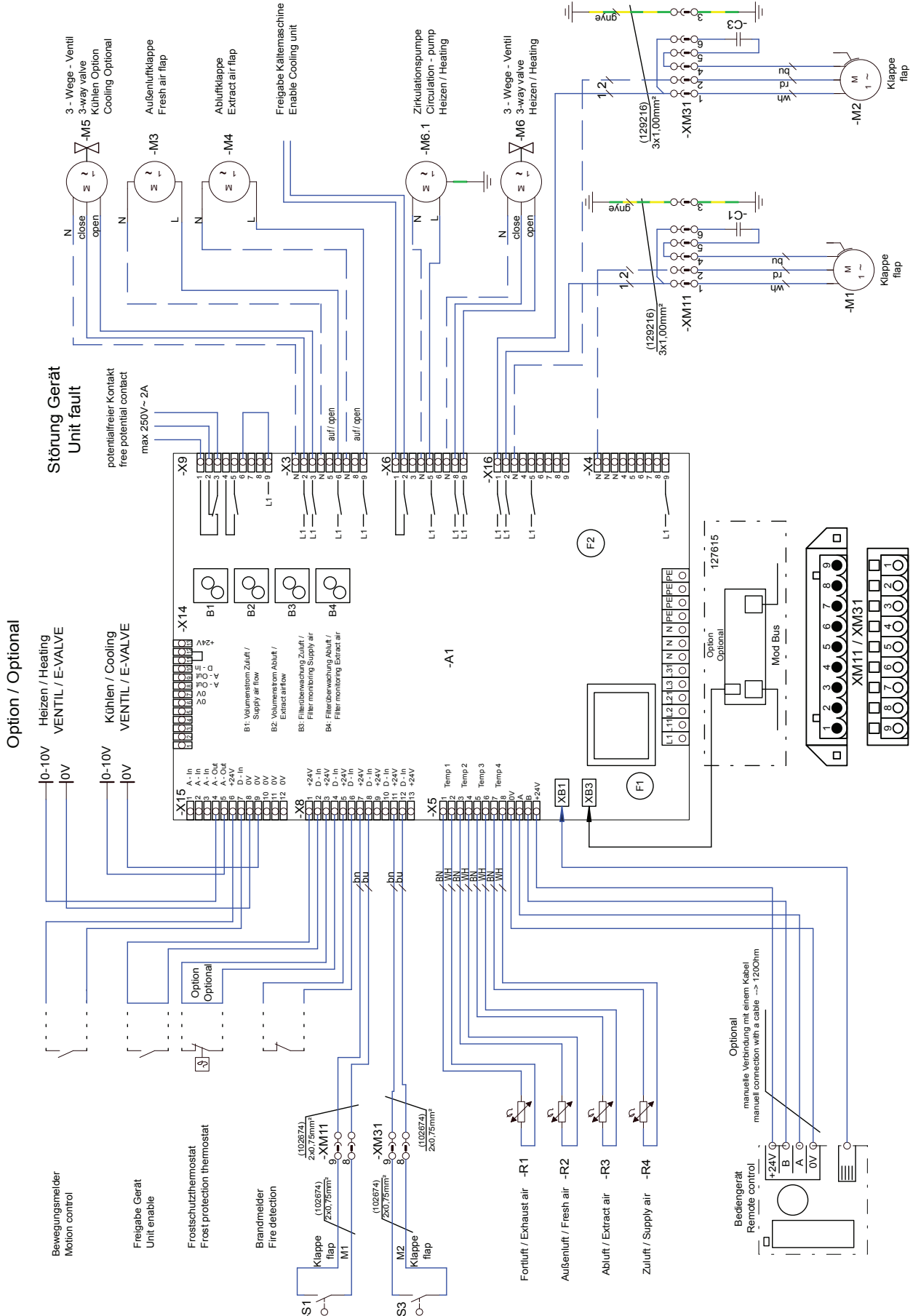

**ACCU K 1200** Wiring diagram No.: 146098 Part 1

Netzspannung : 230V / 1~ / N / 50Hz  
 Mains voltage

Steuerspannung : 24V DC  
 control voltage

Vorsicherung : 16A  
 Fuse

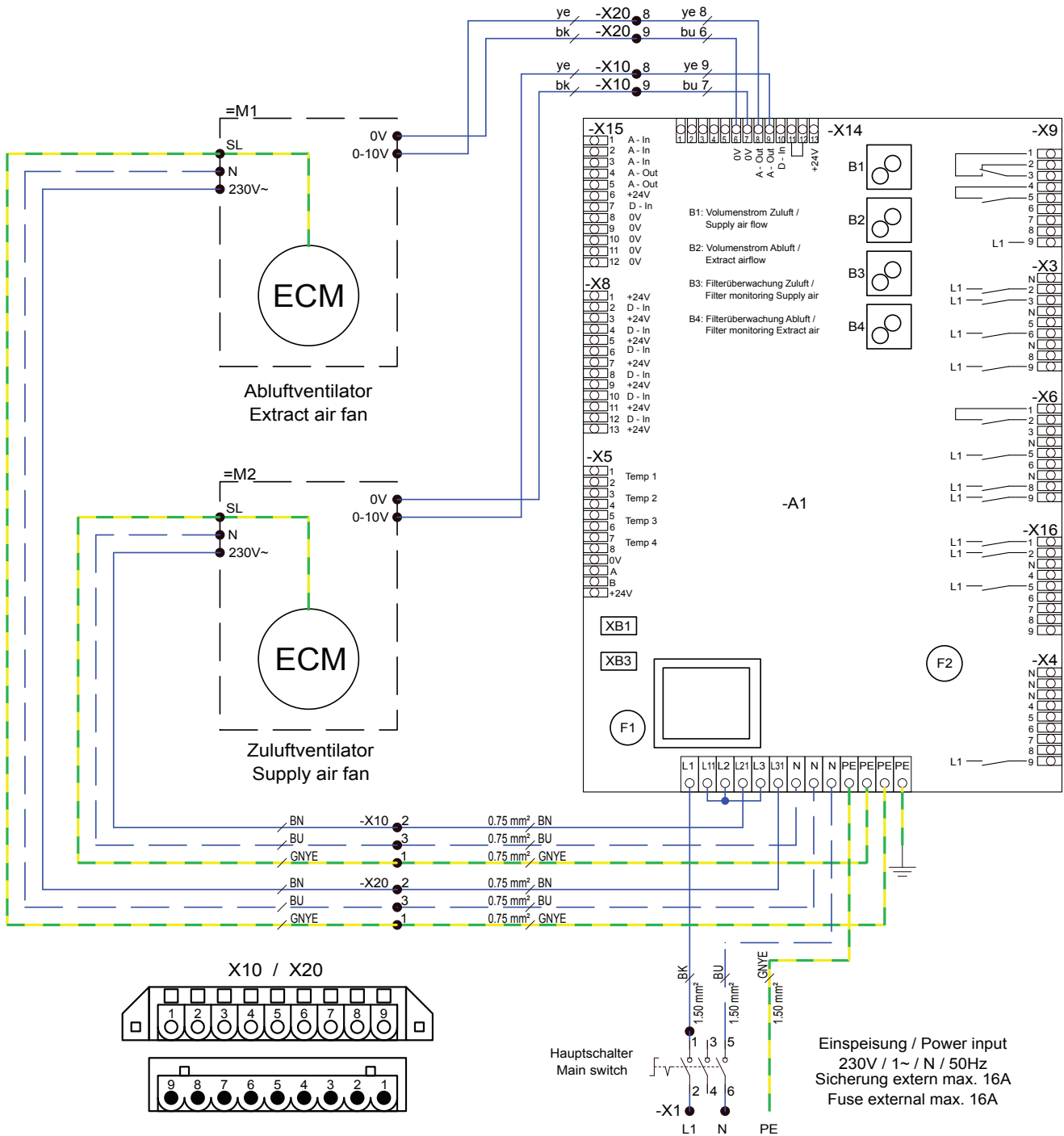

Einspeisung / Power input  
 230V / 1~ / N / 50Hz  
 Sicherung extern max. 16A  
 Fuse external max. 16A

**ACCU K 1200** Wiring diagram No.: 146098 Part 2

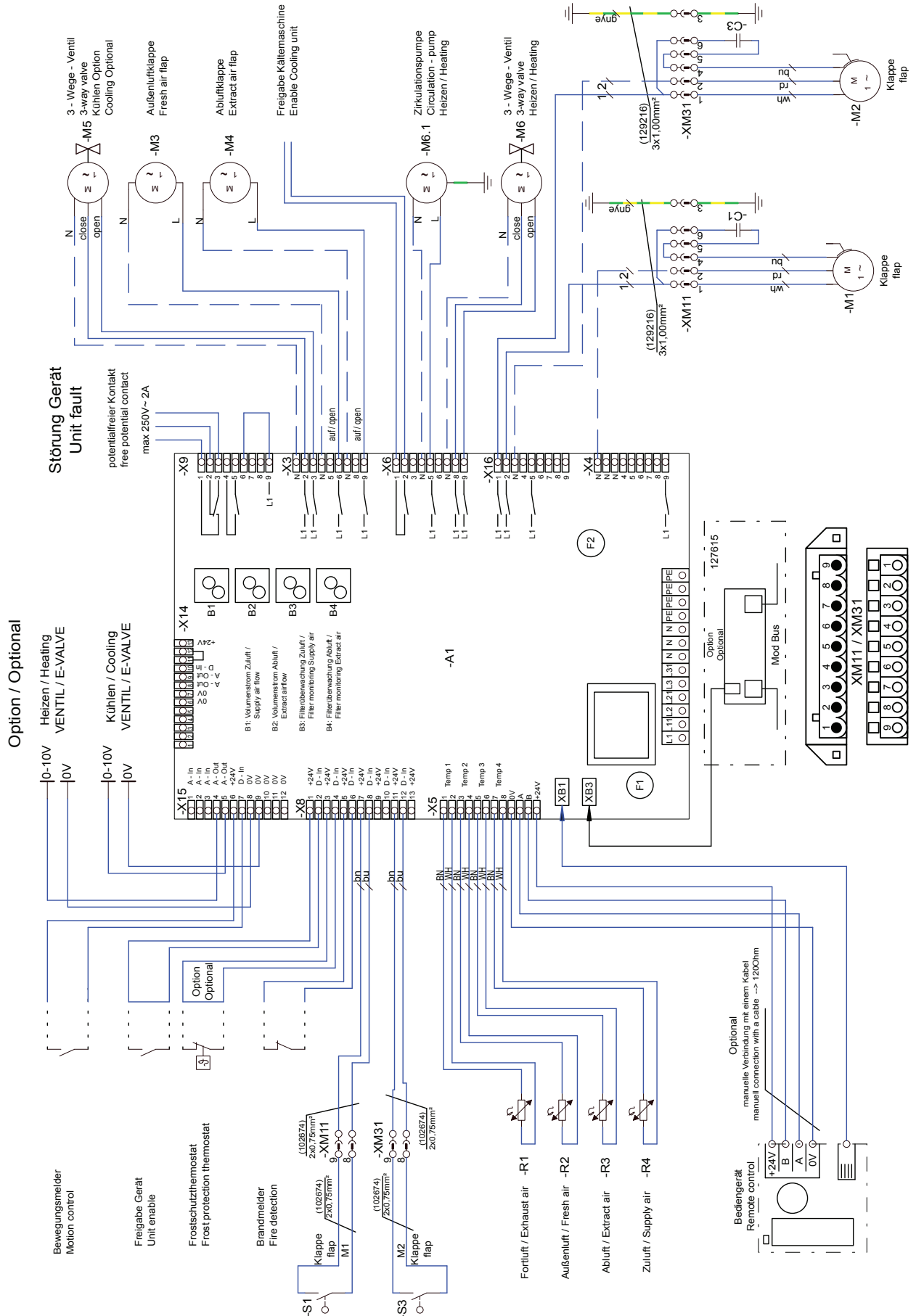

**ACCU K 2400** Wiring diagram No.: 146098 Part 1

Netzspannung : 400V 3~ / N / 50Hz  
 Mains voltage

Vorsicherung : 3 x 16A  
 Fuse

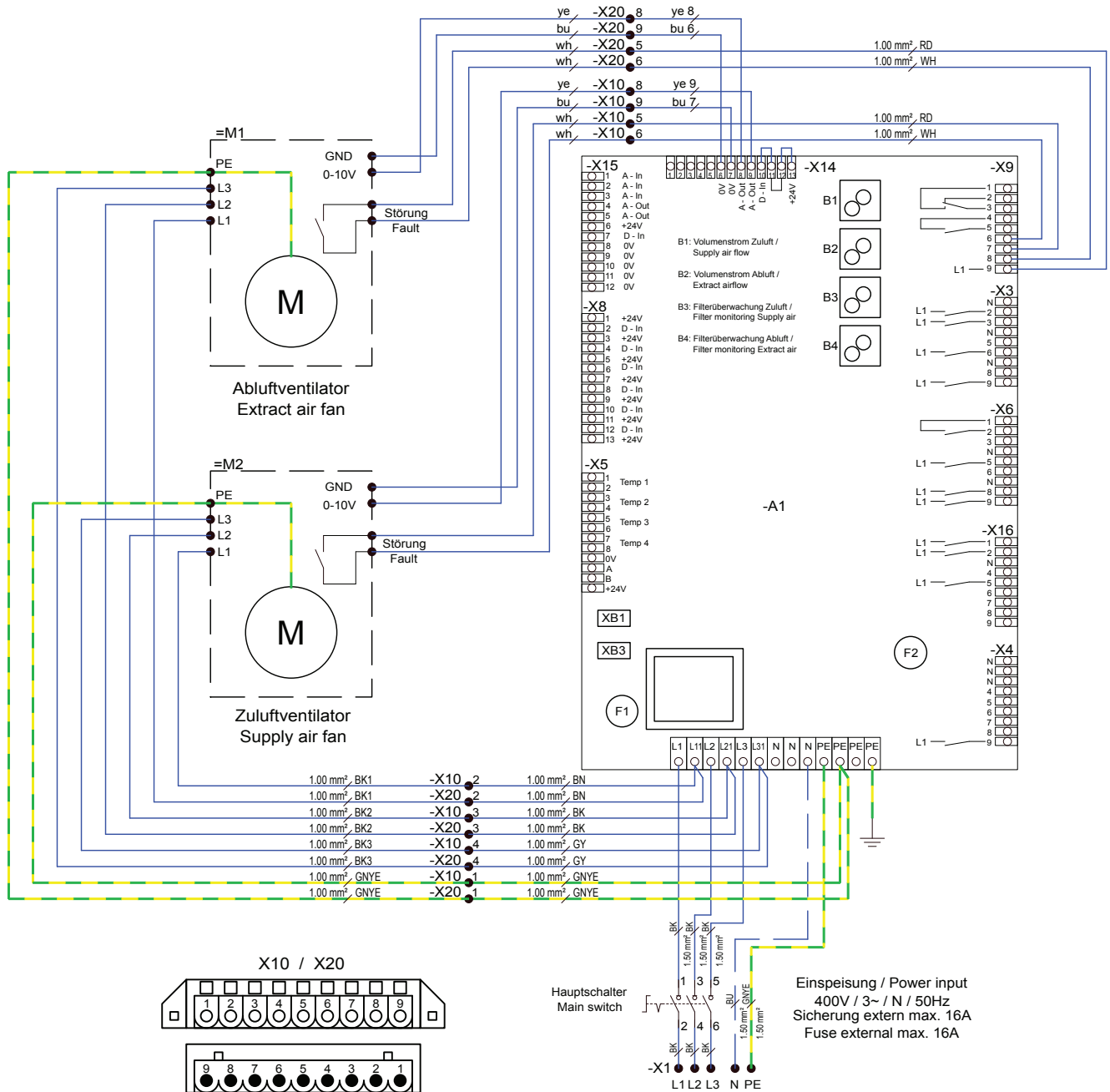



ACCU K 2400 Wiring diagram No.: 146098 Part 2

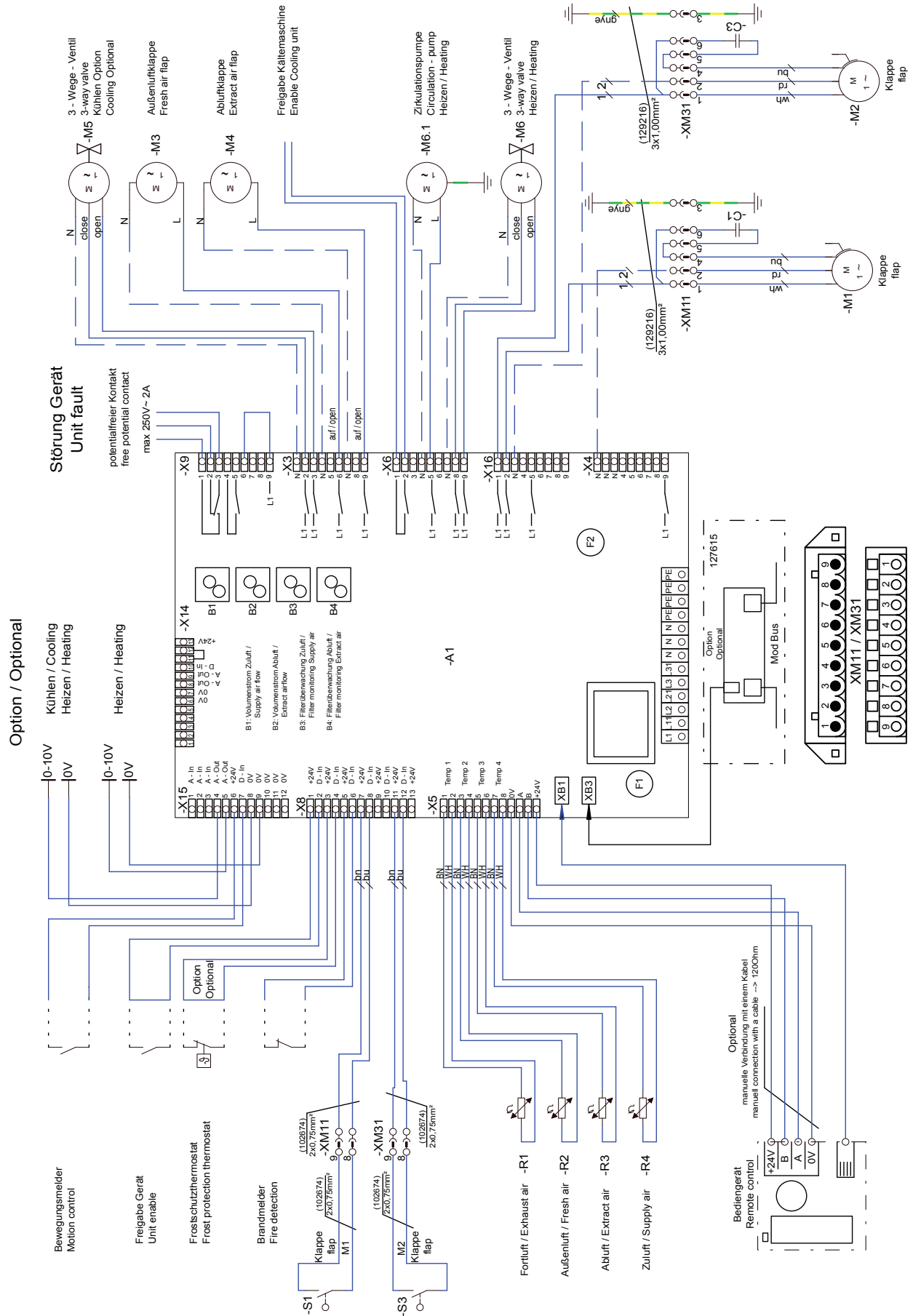

ACCU K 600/1200/2400 Wiring diagram No.: 143169/146098 Part 3

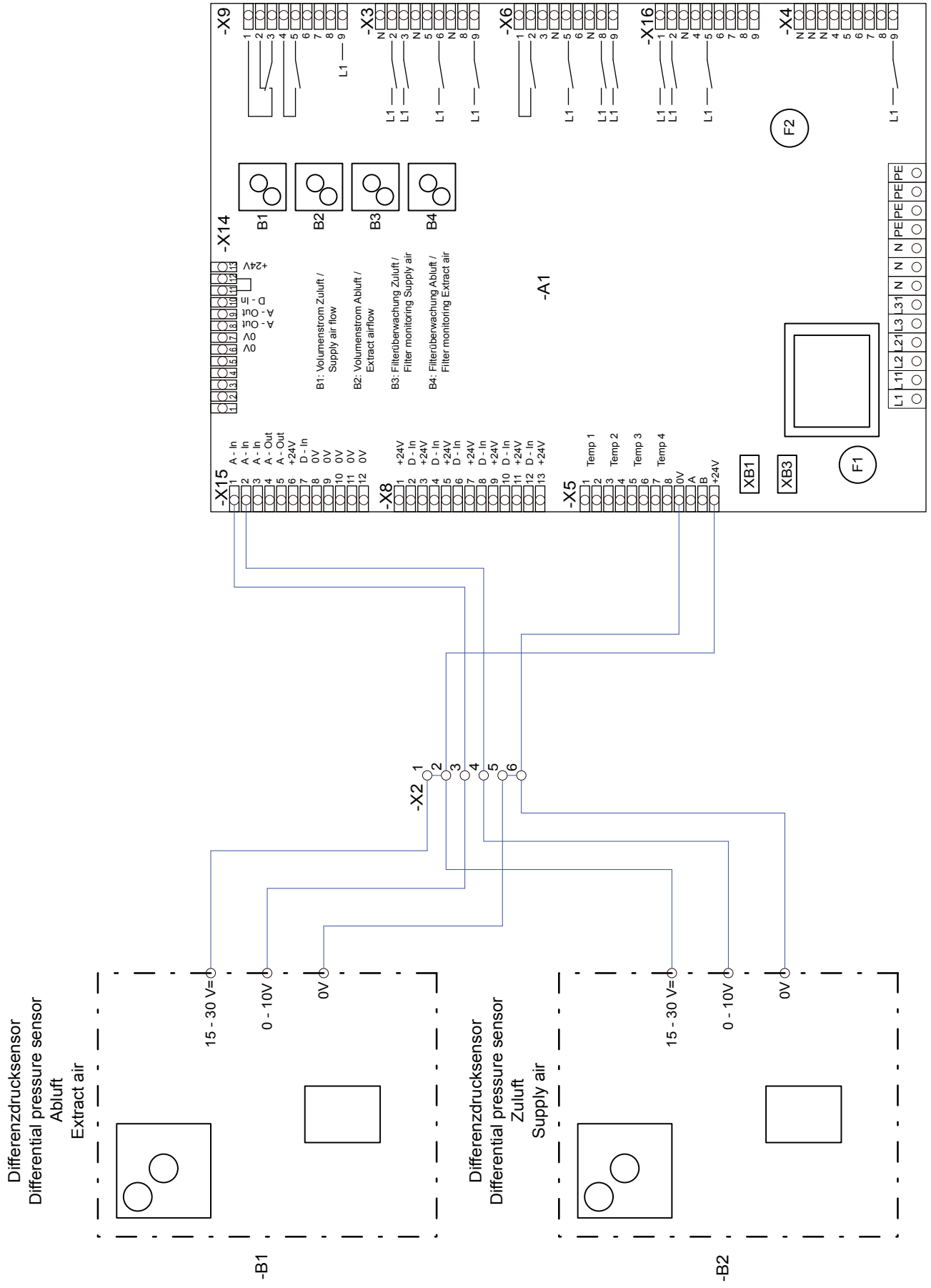

ACCU K 600/1200/2400 Wiring diagram No.: 143169/146098 Part 4

extern Sensor (CO2, VOC)  
external Sensor (CO2, VOC)

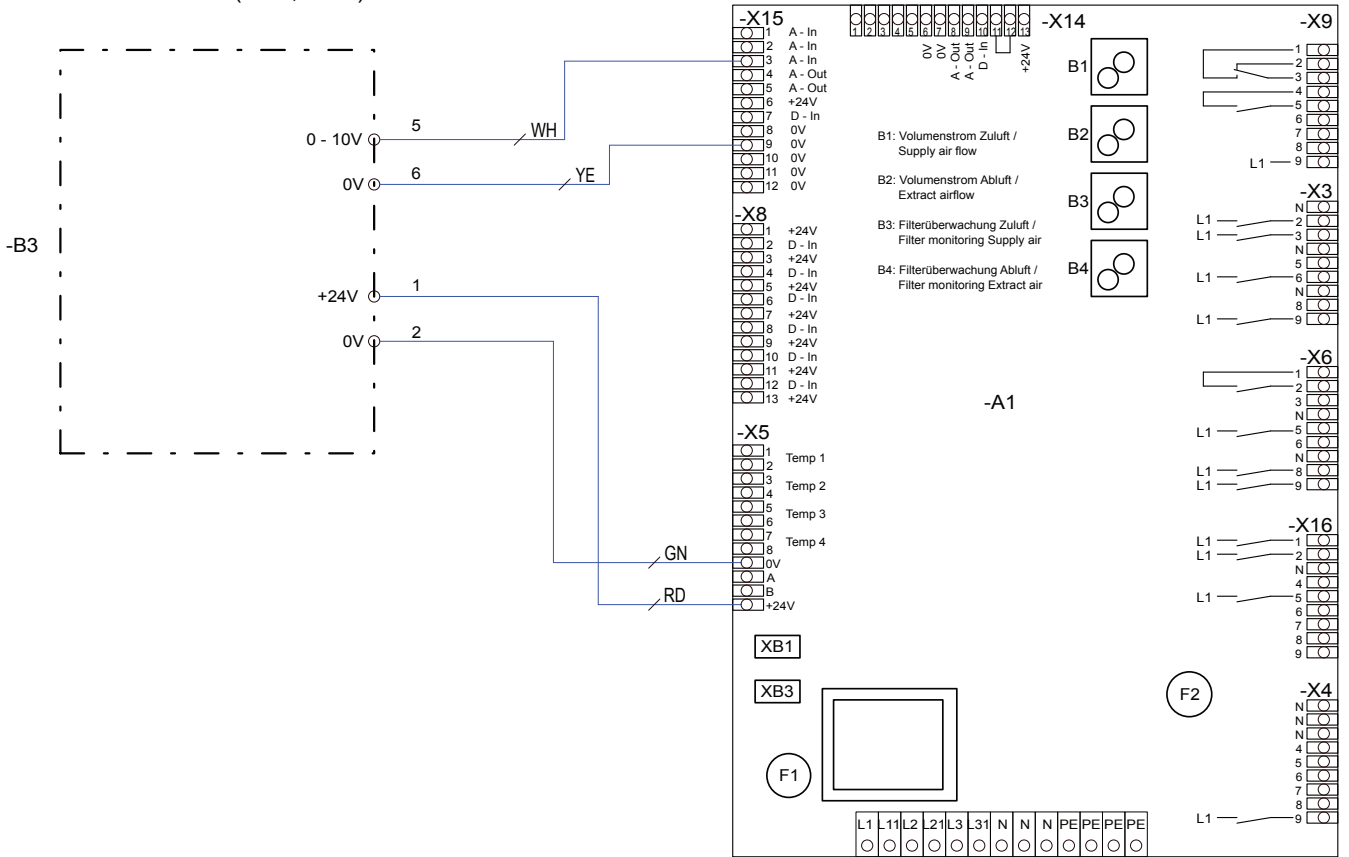



# Notes:

A series of horizontal dotted lines spanning the width of the page, intended for taking notes.

**ruck Ventilatoren GmbH**

Max-Planck-Str. 5  
D-97944 Boxberg-Windischbuch

Tel. +49 (0)7930 9211-0

Fax +49 (0)7930 9211-150

info@ruck.eu

www.ruck.eu

The data specified above only serve to describe the product. No statements concerning a certain condition or suitability for a certain application can be derived from our information.

The information given does not release the user from the obligation of own judgment and verification.

It must be remembered that our products are subject to a natural process of wear and aging.

This document, as well as the data, specifications and other information set forth in it, are the exclusive property of **ruck Ventilatoren GmbH**. It may not be reproduced or given to third parties without its consent.

Information updated

print 16.10.2018

mwa\_kf\_pb\_03\_en

We reserve the right to make changes

Language:

English