

Regulating dampers with actuator mounting **DASML / DASM**



Description

Dampers with actuator mounting are available in diameters of Ø80 to Ø630 mm, including intermediate sizes. The actuator mounting is designed to enable cladding with up to 50 mm thick insulation.

The standard version permits a lengthwise actuator orientation

For fast assembly of actuators, we recommend specially designed DA-SUP-S and DA-SUP-M mounting plates.

Actuators matching DA-SUP-S mounting plate	Actuators matching DA-SUP-M mounting plate
Alnor DM-LM-06	Alnor DM-LM-06
Belimo CM	Alnor DM-LM-08
Belimo LM	Belimo CM
Belimo TR	Belimo NM

UWAGA! Podstawki DA-SUP występują tylko w wersji wzdłużnej!

The DASML/DASM dampers are a good choice when the ductwork closure does not have to be fully airtight.

The opening angle can be fixed with a mechanical limiter installed directly on the actuator.

For outdoor installations, the actuator must be protected from UV light and weather.

All dampers can be provided with various types of actuators on request.

DASM — shutoff damper with actuator mounting

DASML — airtight shutoff damper with gaskets at flanges and actuator mounting

Available materials — Product code examples

DASML-...-... — galvanized steel sheet

Product code example

Product code: **DASML - aaa - bbb**

type

Ød₁

orientation of the actuator mounting

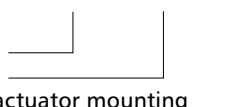

Dimensions

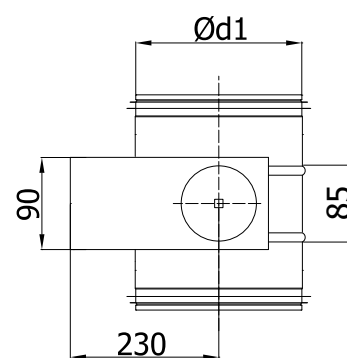
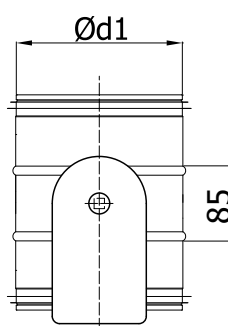
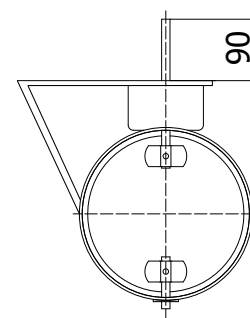
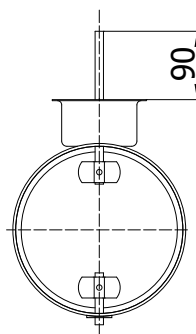

Standard: lengthwise actuator orientation

P — crosswise actuator orientation

DA-SUP-S mounting plate

DA-SUP-M mounting plate

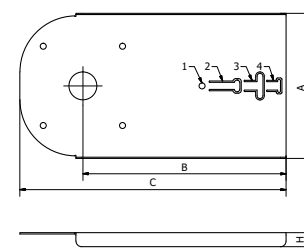
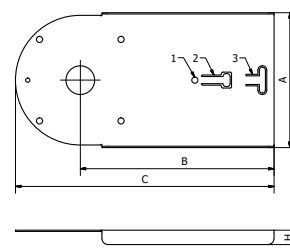

DA-SUP-S mounting plate			DA-SUP-M mounting plate		
A [mm]	B [mm]	C [mm]	A [mm]	B [mm]	C [mm]
94	135	182	104	145	190

DA-SUP-S/M mounting plate is mounted lengthwise only!

Ød _{1 nom} [mm]	Weight [kg]	Ød _{1 nom} [mm]	Weight [kg]
80	0.6	355	2.2
100	0.7	400	2.7
125	0.8	450	3.7
160	0.9	500	4.3
200	1.1	560	5.0
250	1.4	630	5.8
315	1.7		