

Introduction

CR24-B.. only

The control functions define the behavior of the controller outputs and influence the current setpoint.

Both the level of comfort and the energy saving potential can be significantly enhanced by installing suitable sensors on the input side.

Please refer to the table on page 3 for an overview of the functions of the three basic CR24-B.. types. These functions are described in detail below.

Setpoint calculation

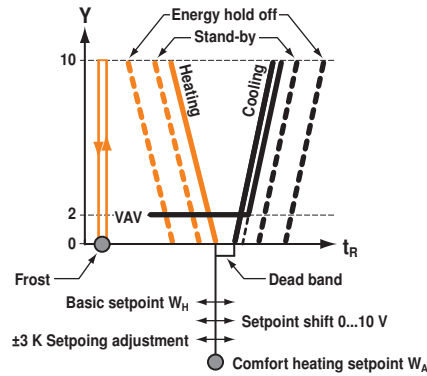

Operating status	Heating setpoint	Cooling setpoint
Comfort	Basic setpoint W_H ± 3 K Setpoint adjustment + Setpoint shift 0...10 V	Comfort heating setpoint W_A + 1 K Dead band
Stand-by	Comfort heating setpoint W_A - 2 K Stand-by offset heating	Comfort heating setpoint W_A + 1 K Dead band + 3 K Stand-by offset cooling
Energy hold off	Fixed 15°C (building protection)	Fixed 40°C (building protection)
Frost	Fixed 10°C	Not relevant

Examples Comfort

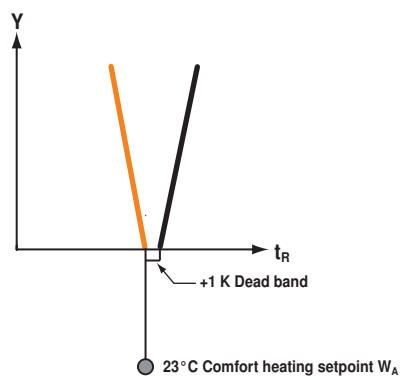

Stand-by

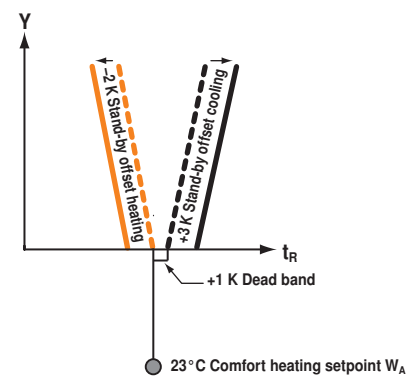

Energy hold off

Digital input di1

all CR24-..

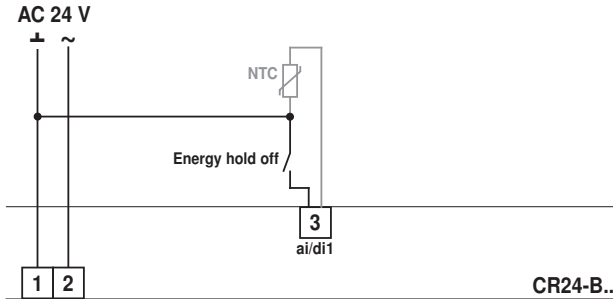

If a local detector (e.g. a window switch) acts on the digital input di1 and closes the corresponding contact, the room is adjusted to the building protection settings in energy saving mode, in other words the heating setpoint is significantly reduced (15°C) or the cooling setpoint significantly increased (40°C), though not sufficiently to cause damage to sensitive objects (plants, paintings etc.).

Typical applications

- A window switch at di1 stops all energy consumption from the moment the window is opened until the lower or upper building protection limit is reached.
- Higher-level override command, e.g. building management system.

Notes

- The minimum VAV output is set to 0 V instead of 2 V while energy hold off is active (forced closing in 2...10 V)
- The mode switch (operator level 1) is deactivated while energy hold off is active (input di1 takes priority).
- If an external temperature sensor is used, the frost limit is monitored by the internal sensor while energy hold off is active.
- Due to the automatic sensor detection the change into energy hold off takes about 40 seconds.

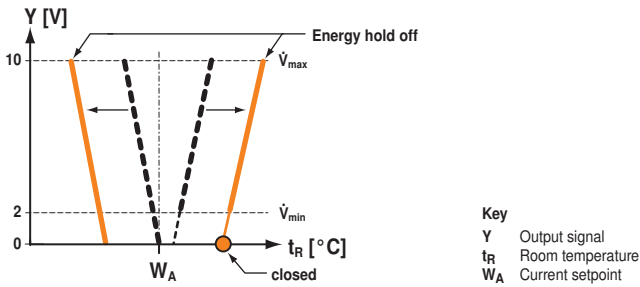

Stand-by

Digital input di2

all CR24-..

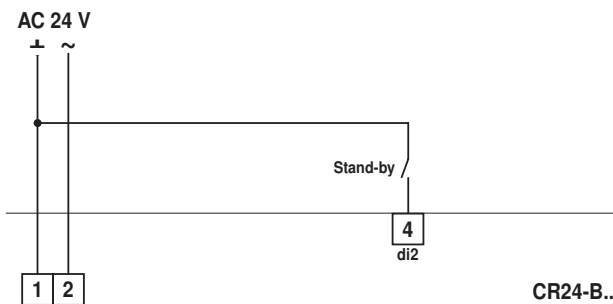

If a local detector (e.g. a motion detector) acts on the digital input di2 and closes the corresponding contact, the room is adjusted to the stand-by settings, in other words the heating setpoint is reduced by 2 K or the cooling setpoint is increased by 3 K.

Typical applications

- A motion detector, a light switch or another detector at di2 reduces the energy consumption of unoccupied rooms.
- Higher-level override command, e.g. building management system.

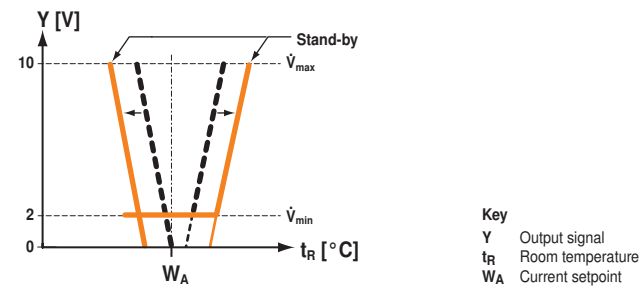

VAV function: air volume in heating mode (Reheater)

CR24-B2 und CR24-B3 only

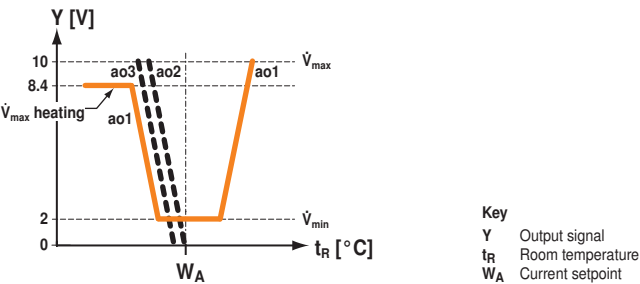

If the selected application requires an increased air volume for heating, e.g. for:

- Providing or assisting heating with air.
- Improving the air quality during heating.

CR24-B2 configuration

The VAV function is configured using DIP switch 2.



CR24-B3 configuration

The VAV function is configured using DIP switch 2.



Electric air heater

CR24-B2E only

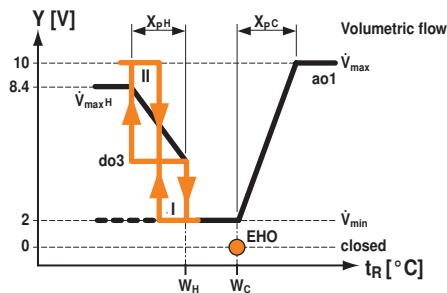

If the selected application requires an increased air volume for heating, e.g. for:

- Provision without assisting heating with air
- Improving the air quality during heating

CR24-B2E configuration

This function is activated using DIP switch 2.



External temperature sensor

Analog input ai1

CR24-B1, CR24-B2, CR24-B3

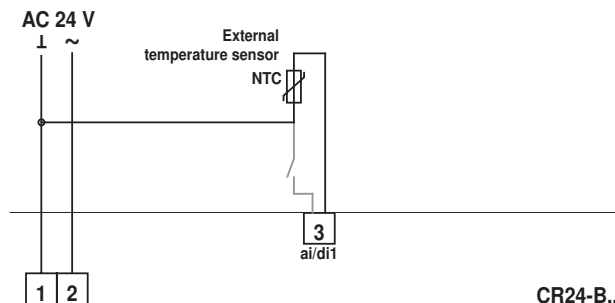

An external NTC temperature sensor can be connected to the analog input ai1.

Typical application

A temperature sensor measures the average room temperature in the exhaust air duct.

Notes

- The internal sensor automatically detects the presence of an external sensor.
- It is possible to install an energy hold off switch simultaneously at di1, in which case the system changes over to the internal sensor (see also "Energy hold off"). This permits the actual room temperature to be monitored in order to protect the building.

Supply air temperature limitation

Analog input ai1

CR24-B2E only

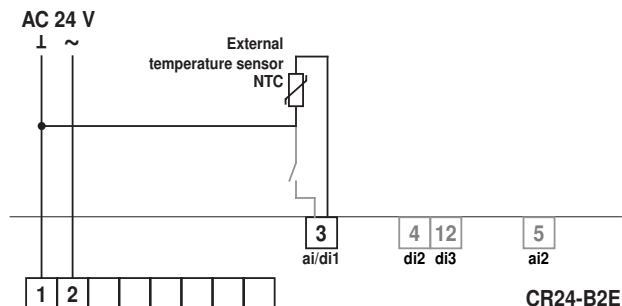

An external NTC temperature sensor can be connected to the analog input ai1. Sensor type: NTC 5k (5 kΩ)

Function: The temperature of the supply air is limited by shedding individual load increments if the maximum temperature is exceeded. This results in an almost modulating control characteristic.

Benefits: Increased comfort and economical energy consumption

Notes

- The controller automatically detects the presence of a supply air limitation sensor.
- Combined application with EHO switch:
EHO active = supply air temperature limitation not active

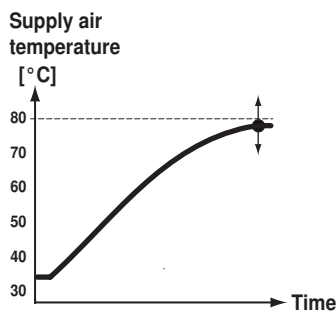

Without supply air limitation

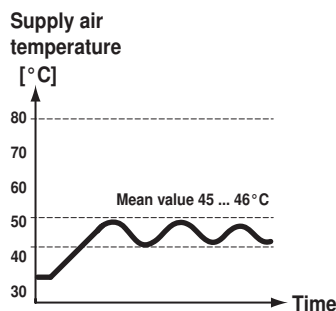

With supply air limitation

External setpoint shift

Analog input ai2

all CR24-..

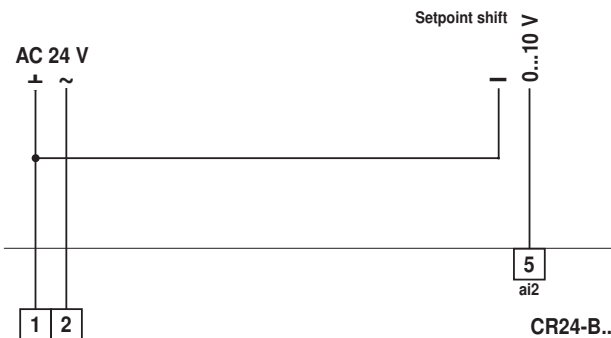

An external DC 0...10 V signal at the analog input ai2 can be used to shift the basic setpoint 0...10 K (corresponds to 0...10 V).

Typical application

- Summer/winter compensation

Notes

A negative shift can be achieved by adjusting the basic setpoint to the required final setpoint, e.g. from 21 °C (default value) to 16 °C. In this case:

- 0... 5 V corresponds to 16...21 °C and
- 5...10 V corresponds to 21...26 °C (see diagram opposite).

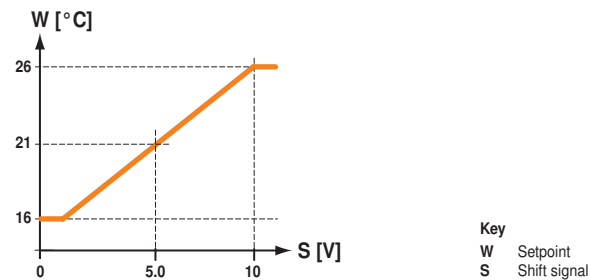

Air flush

Digital input di3

CR24-B2 only

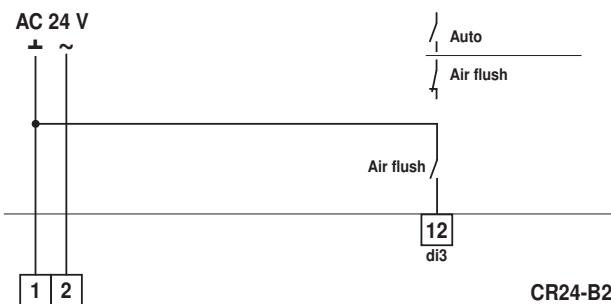

The CR24-B2 controller allows override control at the digital input di3, to enable the room to be flushed with the maximum volume flow (\dot{V}_{max}).

Typical applications

- Purging conference rooms, hotel rooms etc. (e.g. time switch-controlled)
- Assisting smoke extraction
- Controlling air quality (2-point signal)

Notes

- The VAV output ao1 is set to a fixed value of \dot{V}_{max} (10 V).
- The heating output ao3 remains in the normal control mode and continues to be controlled by means of the heating sequence.

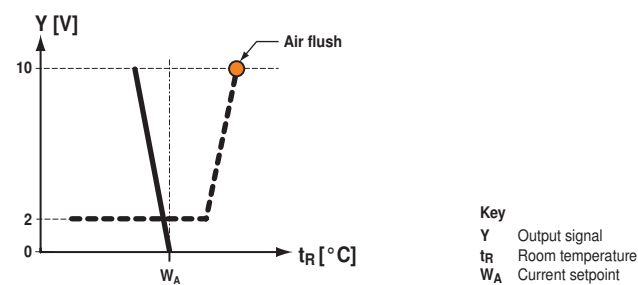

Change-over ao1

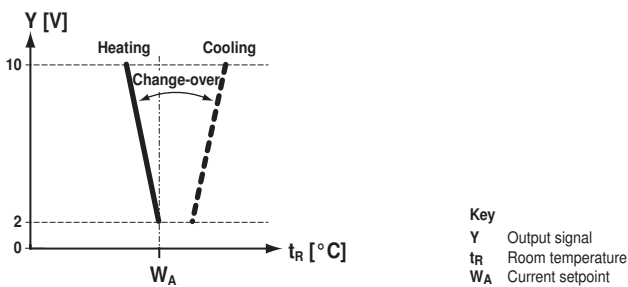
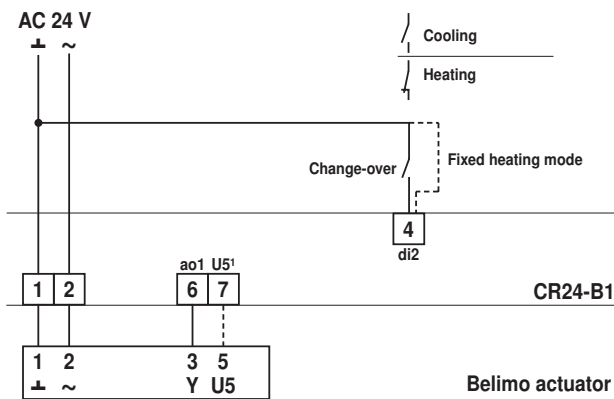

Digital input di2

CR24-B1 only

In change-over applications, the digital input di2 controls the VAV system output ao1 of the CR24-B1 controller.

Typical applications

Change-over heating or heating/cooling.

Note

The CR24-B3 controller is suitable for applications that require both a stand-by function and a change-over function.

Configuration

The change-over function is configured using DIP switch 2



Change-over ao2

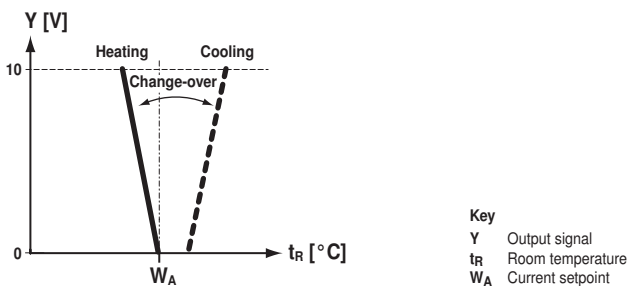
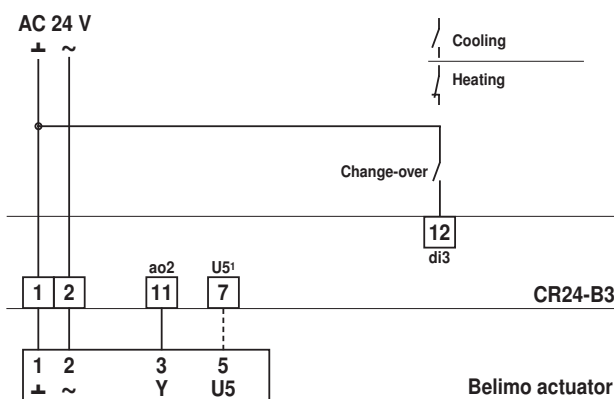

Digital input di3

CR24-B3 only

In change-over applications, the digital input di3 controls the common heating/cooling output ao2 of the CR24-B3 controller.

Typical applications

Change-over heating or heating/cooling.

Note

- For chilled ceiling applications, refer to page 23.
- The CR24-B1 controller is suitable for applications that only require a change-over function.

Configuration

The change-over function is configured using DIP switches 3 and 4.



Boost – \dot{V}_{max}

Digital input di3

CR24-B3 only

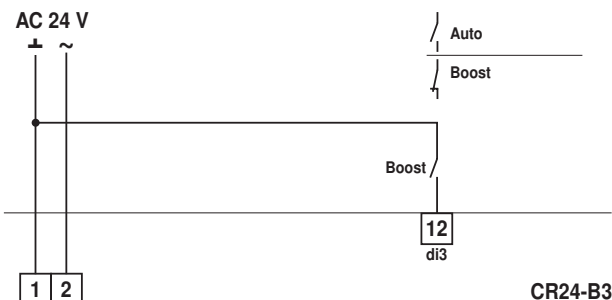

The CR24-B3 controller allows override control at the digital input di3, to enable the room to be ventilated with the maximum air flow (\dot{V}_{max}). This function acts on all three analog outputs (see "Notes"). Room temperature control is deactivated in this mode (exception: frost protection function).

Typical applications

- Purging conference rooms, hotel rooms etc.
- Assisting smoke extraction
- Free- or night cooling

Notes

The boost function acts on the outputs as follows:

- ao1 (VAV) 100% > 10 V (\dot{V}_{max})
- ao2 (heating/cooling) 0% > 0 V
- ao3 (heating) 0% > closed (3-point)

The boost function is deactivated by the following events:

- Boost signal (di3) not active
- Frost limit temperature (10°C) undershot

Configuration

This boost function is configured using DIP switches 4 (boost on) and 5 (boost \dot{V}_{max}).

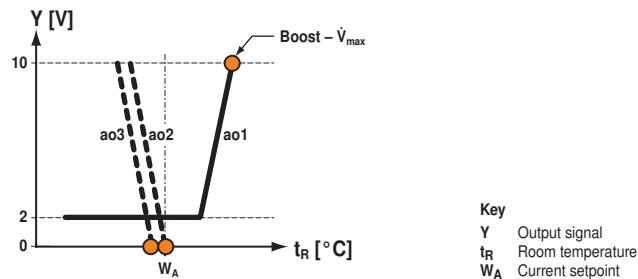

Boost – Temperature-controlled

Digital input di3

CR24-B3, CR24-B2E

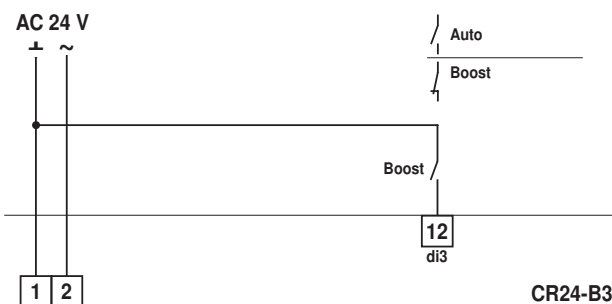

The CR24-B3 resp. CR24-B2E controller allows override control at the digital input di3, to enable the room to be heated or cooled with the maximum capacity. This function acts on all three analog outputs (see "Notes").

Typical applications

- Rapid heating, rapid cooling
- Cooling, morning boost etc.

Notes

The boost function acts temperature-sensitive on the outputs as follows

- CR24-B3:
- ao1 (VAV) 100% > 10 V (\dot{V}_{max})
 - ao2 (heating/cooling) 100% > 10 V
 - ao3 (heating) 100% > open (3-point)

- CR24-B2E:
- ao1 (VAV) 100% > 10 V (\dot{V}_{max})
 - do3 / 1 ON
 - do3 / 2 ON

To support reheater applications the VAV system output (ao1) gets activated at the heating condition too.

The boost function is deactivated by the following events:

- Boost signal (di3) not active
- Comfort setpoint (W) reached

The air is always conditioned to the comfort setpoint W, even if stand-by (d1) is active, in order to facilitate room preconditioning.

Configuration (CR24-B3 only)

This boost function is configured using DIP switches 4 (boost on) and 5 (boost temperature-controlled).

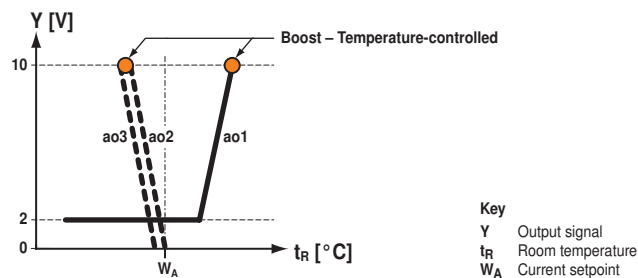

Chilled ceiling with dew point limiting

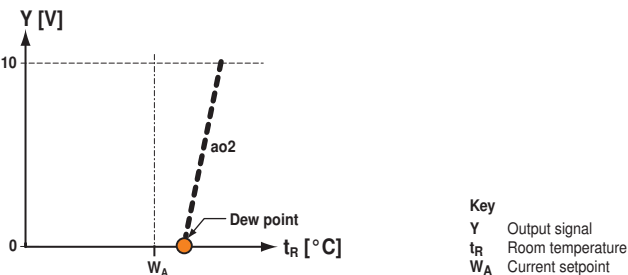
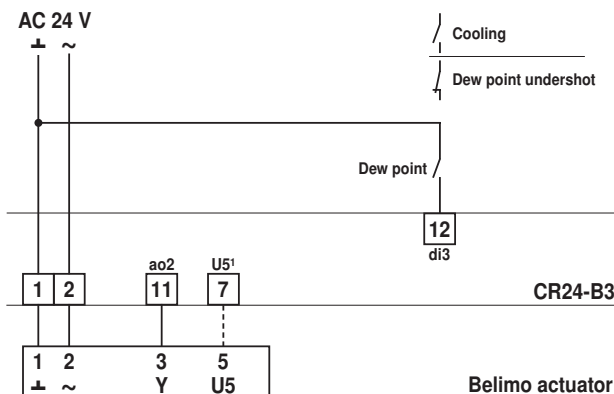

Digital input di3

CR24-B3 only

If the temperature at the external dew point monitor (input di3) falls below the dew point, output ao2 is set to 0 V.

Typical applications

Chilled ceiling systems that require dew point limiting.

Configuration

This function is configured using DIP switches 3 and 4.



Chilled ceiling with dew point limiting and change-over

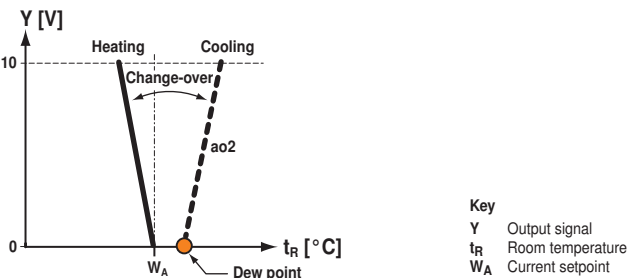
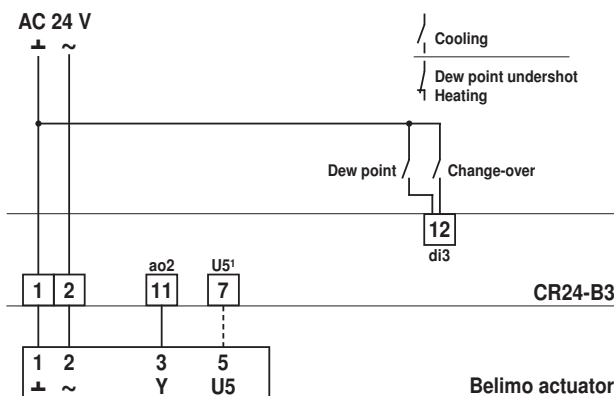

Digital input di3

CR24-B3 only

If the temperature at the external dew point monitor (input di3) falls below the dew point, output ao2 is set to 0 V. Dew point limiting can be combined with the change-over function.

Typical applications

Switchable heated/chilled ceiling systems that also require dew point limiting.

Configuration

This function is configured using DIP switches 3 and 4.



Rolling start

CR24-B2E only

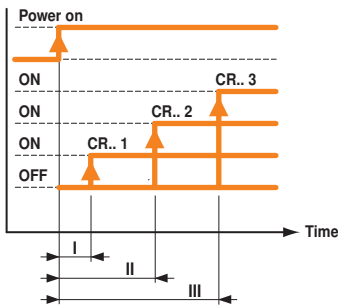

An ingenious startup function prevents overload situations when the power is switched on and stops fuses from being tripped if several air heaters are operated with the same voltage supply.

Power-on behavior

- Power on
- Delay I Electric air heater of the first CR24-B2E enabled
- Delay II Electric air heater of the second CR24-B2E enabled
- Delay III Electric air heater of the third CR24-B2E enabled
- etc.

Excess temperature protection

CR24-B2E only

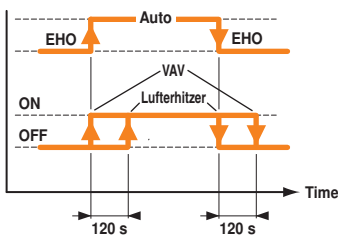

This function prevents the local safety interlock (STh) from responding unless absolutely necessary and relieves the load on devices and installations.

When the system is started up after a power on or EHO off, or when EHO active is switched off, the air heater output is switched on after a delay and the VAV output is switched off after a delay.

Step control

CR24-B2E only

Single steps

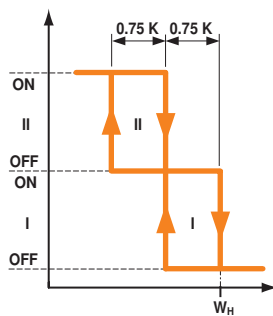

The B2E supports two AH control modes:

- Single steps: Simple electric air heaters or open/close radiator/zone valves
- Binary steps: 2-step electric air heaters in 3-step mode, e.g. 1/3 – 2/3 – 3/3

CR24-B2E configuration

This function is configured using DIP switch 1.

- Einzelstufen: Simple electric air heaters or open/close radiator/zone valves



(Factory setting)

Binary steps

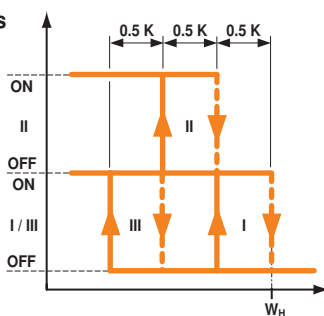

- Binärstufen: 2-step electric air heaters in 3-step mode, e.g. 1/3 – 2/3 – 3/3

