

Datasheet

Product type: **Round inlet spigot**
Product ID: 154302
Product name: RAS 400 F4

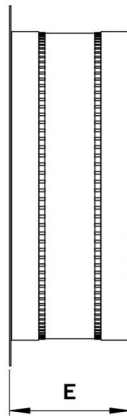
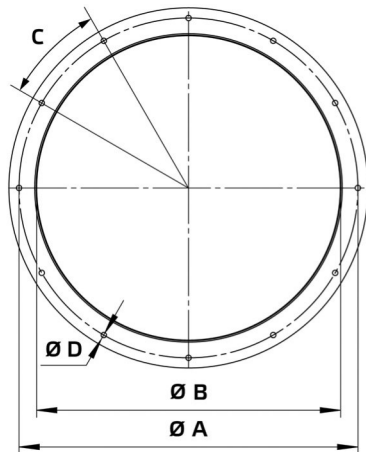

A	mm	450
B	mm	400
C		12 x 30°
D	mm	8
E	mm	105 ... 175
Weight	kg	3.7

- Flexible connection
- Continuous temperature 75°C
- Sheet steel, galvanized
- Silicone band
- Temperature class according to DIN EN 12101-3 F400 (400°C/120min)

Use:

- AL 400 D4 F4 01
- AL 400 D2 F4 01