

Datasheet

Product type: **Round inlet spigot**
Product ID: 154301
Product name: RAS 355 F4

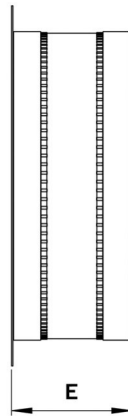
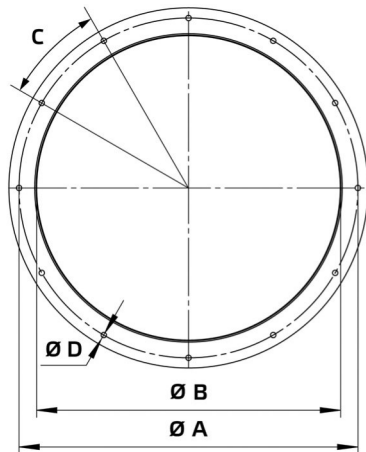

A	mm	395
B	mm	355
C		10 x 36°
D	mm	8
E	mm	120 ... 190
Weight	kg	3.3

- Flexible connection
- Continuous temperature 75°C
- Sheet steel, galvanized
- Silicone band
- Temperature class according to DIN EN 12101-3 F400 (400°C/120min)

Use:

- AL 355 D4 F4 01
- AL 355 D2 F4 01